

AEGIS PLUS®



COMMERCIAL ORNAMENTAL STEEL FENCE

Aegis Plus combines *strength greater than most industrial steel fences* with a surface finish that is essentially maintenance-free. The size of Aegis Plus works well for numerous applications where users are seeking greater strength and a *more substantial look without the high cost of industrial fencing.*



PRIMARY APPLICATIONS

- **Municipal Facilities**
- **Self Storage**
- **Parks & Recreation**
- **Event Centers**
- **K-12 Schools**
- **Childcare Facilities**



FENCE PRODUCTS

AMERISTARFENCE.COM | 888-333-3422

Experience a safer and more open world

AMERISTAR®

ASSA ABLOY

AEGIS PLUS[®]

COMMERCIAL ORNAMENTAL STEEL FENCE

.75"sq x 17ga PICKETS | 1.5" x 1.5" x 14ga ForeRunner[™] RAILS | 2.5"sq x 12ga POSTS

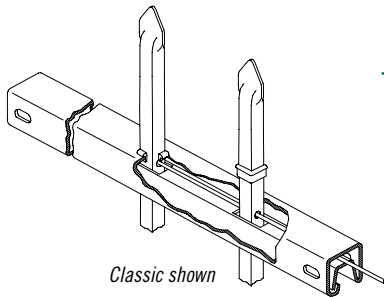

STYLE OPTIONS

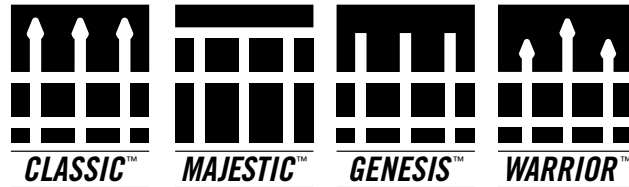

FABRICATION & DESIGN

Ameristar crafted the ForeRunner rail to increase strength through architecture. The innovative design of the ForeRunner rail contains an internally secured rod that allows for variable pitch connection, high angle biasability and eliminates the need for visually unappealing external fasteners. Galvanized inside and out; to protect against internal corrosion; puts the ForeRunner rail in the upper echelon of fencing options.



PERMACOAT[™] PROTECTIVE FINISH

Ameristar's production facilities use a state-of-the-art polyester powder coating system that provides a durable and scratch resistant finish. Aegis is protected with Ameristar's PermaCoat multi-layer coating process. The combination of these layers delivers a system that increases weathering resistance and product durability. The Ameristar coating system results in finished surfaces with unmatched performance.



10 YEAR LIMITED WARRANTY

The family of Aegis steel fencing products are manufactured from the highest quality materials by skilled craftsmen to meet the highest standards of workmanship in the industry. This is why Ameristar proudly offers a limited 10 year warranty.



DOMESTIC MANUFACTURING

Ameristar is committed to providing products that are manufactured in the USA. We have made significant investments in technology, process improvement, and employee training in an effort to secure American jobs and combat inferior import products.



FENCE PRODUCTS

TO PLACE YOUR ORDER CALL 888-333-3422

VISIT AMERISTARFENCE.COM

AEGIS PLUS® | 2 & 3-RAIL OPTIONS | 4" AIR-SPACE

STANDARD BOTTOM OPTION AVAILABLE

PATENT NUMBERS: 6254064, 7461833, D566292, D573270, D620128, D622870

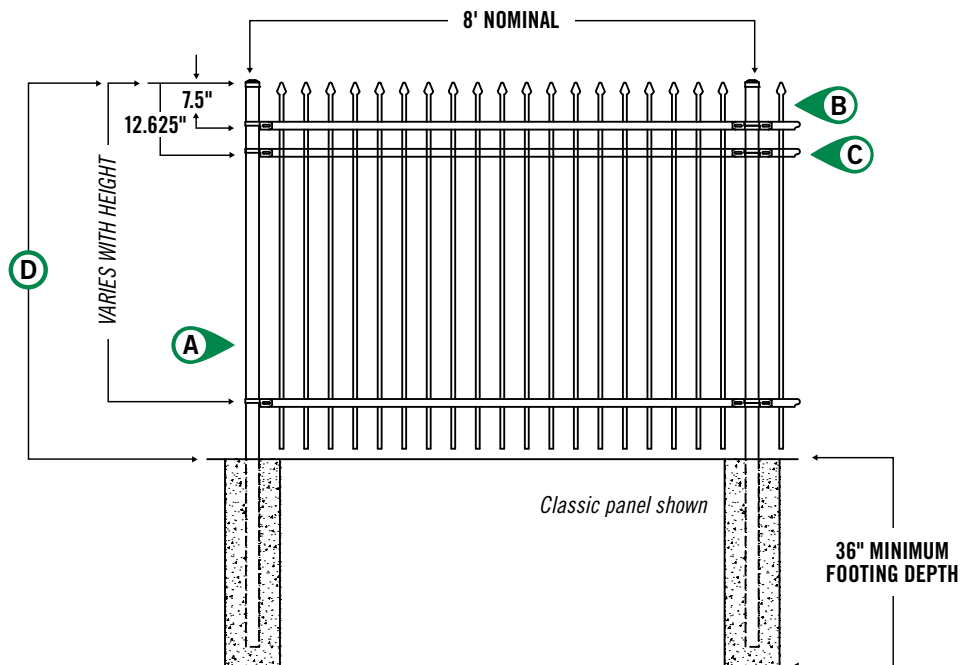

- Ⓐ 2.5"sq x 12ga POSTS
- Ⓑ 0.75"sq x 17ga PICKETS
- Ⓒ 1.5" x 1.5" x 14ga ForeRunner RAILS
- Ⓓ 3', 3.5', 4', 5', 6', 7' & 8' PANEL HEIGHTS

PANELS REQUIRE ASSEMBLY

Refer to construction specification & tables within this section for recommended post space by bracket type

Effective: 01/05/21

AEGIS PLUS® | 2-RAIL PANELS | 8' PANEL LENGTH

STANDARD BOTTOM | 8' PANEL LENGTH (92" actual width) | 19 PICKETS PER PANEL | ASSEMBLY REQUIRED

PANEL	ITEM NUMBER	WEIGHT	STOCKING
3'	1 <input checked="" type="checkbox"/> <input checked="" type="checkbox"/> 20348	58 lbs	⊙
3.5'	1 <input checked="" type="checkbox"/> <input checked="" type="checkbox"/> 20408	63 lbs	⊙
4'	1 <input checked="" type="checkbox"/> <input checked="" type="checkbox"/> 20468	68 lbs	⊙
5'	1 <input checked="" type="checkbox"/> <input checked="" type="checkbox"/> 20588	78 lbs	⊙
6'	1 <input checked="" type="checkbox"/> <input checked="" type="checkbox"/> 20708	88 lbs	⊙

= FENCE STYLES AVAILABLE | **C** = Classic **M** = Majestic **G** = Genesis **W** = Warrior

= COLOR OPTIONS AVAILABLE | **B** = Black **N** = Bronze **W** = White **S** = Sand

⊙ = NON-STOCKED PRODUCT

For details, see Ameristar's Sales Policy in the catalog guide.

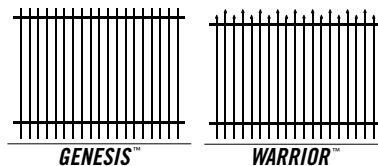
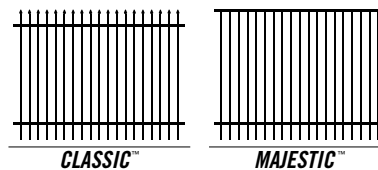

AEGIS PLUS® | 2-RAIL PANELS | 6' PANEL LENGTH

STANDARD BOTTOM | 6' PANEL LENGTH (73.25" actual width) | 15 PICKETS PER PANEL | ASSEMBLY REQUIRED

PANEL	ITEM NUMBER	WEIGHT	STOCKING
3'	1 <input checked="" type="checkbox"/> <input checked="" type="checkbox"/> 20346	43 lbs	⊙
3.5'	1 <input checked="" type="checkbox"/> <input checked="" type="checkbox"/> 20406	47 lbs	⊙
4'	1 <input checked="" type="checkbox"/> <input checked="" type="checkbox"/> 20466	50 lbs	⊙
5'	1 <input checked="" type="checkbox"/> <input checked="" type="checkbox"/> 20586	57 lbs	⊙
6'	1 <input checked="" type="checkbox"/> <input checked="" type="checkbox"/> 20706	64 lbs	⊙

= FENCE STYLES AVAILABLE | **C** = Classic **M** = Majestic **G** = Genesis **W** = Warrior

= COLOR OPTIONS AVAILABLE | **B** = Black **N** = Bronze **W** = White **S** = Sand

⊙ = NON-STOCKED PRODUCT

For details, see Ameristar's Sales Policy in the catalog guide.

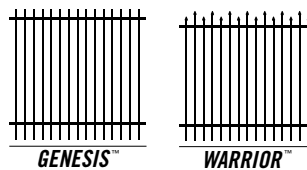
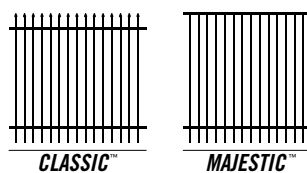

Effective: 01/05/21

AMERISTAR

ASSA ABLOY

TO PLACE YOUR ORDER CALL 888-333-3422 | VISIT AMERISTARFENCE.COM

AEGIS PLUS® | 3-RAIL PANELS | 8' PANEL LENGTH

STANDARD BOTTOM | 8' PANEL LENGTH (92" actual width) | 19 PICKETS PER PANEL | ASSEMBLY REQUIRED

PANEL	ITEM NUMBER	WEIGHT	STOCKING
3'	1 <input checked="" type="checkbox"/> <input checked="" type="checkbox"/> 30348	72 lbs	⊙
3.5'	1 <input checked="" type="checkbox"/> <input checked="" type="checkbox"/> 30408	77 lbs	⊙
4'	1 <input checked="" type="checkbox"/> <input checked="" type="checkbox"/> 30468	82 lbs	⊙
5'	1 <input checked="" type="checkbox"/> <input checked="" type="checkbox"/> 30588	92 lbs	⊙
6'	1 <input checked="" type="checkbox"/> <input checked="" type="checkbox"/> 30708	102 lbs	⊙
7'	1 <input checked="" type="checkbox"/> <input checked="" type="checkbox"/> 30828	112 lbs	⊙
8'	1 <input checked="" type="checkbox"/> <input checked="" type="checkbox"/> 30948	122 lbs	⊙

= FENCE STYLES AVAILABLE | **C** = Classic **M** = Majestic **G** = Genesis **W** = Warrior

= COLOR OPTIONS AVAILABLE | **B** = Black **N** = Bronze **W** = White **S** = Sand

⊙ = NON-STOCKED PRODUCT

For details, see Ameristar's Sales Policy in the catalog guide.

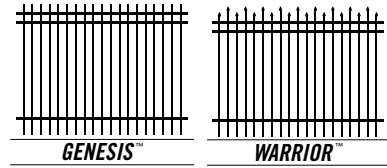
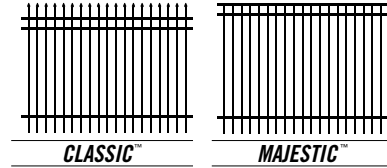

AEGIS PLUS® | 3-RAIL PANELS | 6' PANEL LENGTH

STANDARD BOTTOM | 6' PANEL LENGTH (73.25" actual width) | 15 PICKETS PER PANEL | ASSEMBLY REQUIRED

PANEL	ITEM NUMBER	WEIGHT	STOCKING
3'	1 <input checked="" type="checkbox"/> <input checked="" type="checkbox"/> 30346	54 lbs	⊙
3.5'	1 <input checked="" type="checkbox"/> <input checked="" type="checkbox"/> 30406	58 lbs	⊙
4'	1 <input checked="" type="checkbox"/> <input checked="" type="checkbox"/> 30466	61 lbs	⊙
5'	1 <input checked="" type="checkbox"/> <input checked="" type="checkbox"/> 30586	68 lbs	⊙
6'	1 <input checked="" type="checkbox"/> <input checked="" type="checkbox"/> 30706	75 lbs	⊙
7'	1 <input checked="" type="checkbox"/> <input checked="" type="checkbox"/> 30826	82 lbs	⊙
8'	1 <input checked="" type="checkbox"/> <input checked="" type="checkbox"/> 30946	89 lbs	⊙

= FENCE STYLES AVAILABLE | **C** = Classic **M** = Majestic **G** = Genesis **W** = Warrior

= COLOR OPTIONS AVAILABLE | **B** = Black **N** = Bronze **W** = White **S** = Sand

⊙ = NON-STOCKED PRODUCT

For details, see Ameristar's Sales Policy in the catalog guide.

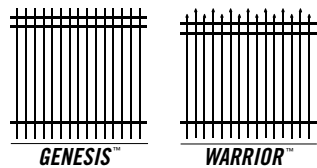
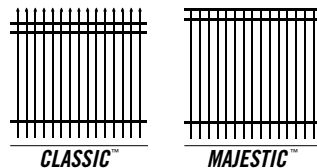

Effective: 01/05/21

AEGIS PLUS® | 3-RAIL PANELS WITH RINGS | 8' PANEL LENGTH

STANDARD BOTTOM | 8' PANEL LENGTH (92" actual width) | 19 PICKETS PER PANEL | ASSEMBLY REQUIRED

PANEL	ITEM NUMBER	WEIGHT	STOCKING
3'	1 ☒ ⊗ 30348R	85 lbs	⊙
3.5'	1 ☒ ⊗ 30408R	90 lbs	⊙
4'	1 ☒ ⊗ 30468R	95 lbs	⊙
5'	1 ☒ ⊗ 30588R	105 lbs	⊙
6'	1 ☒ ⊗ 30708R	115 lbs	⊙
7'	1 ☒ ⊗ 30828R	125 lbs	⊙
8'	1 ☒ ⊗ 30948R	135 lbs	⊙

☒ = FENCE STYLES AVAILABLE | C = Classic M = Majestic G = Genesis W = Warrior

⊗ = COLOR OPTIONS AVAILABLE | B = Black N = Bronze W = White S = Sand

⊙ = NON-STOCKED PRODUCT

For details, see Ameristar's Sales Policy in the catalog guide.

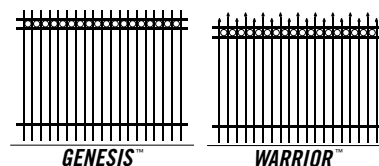
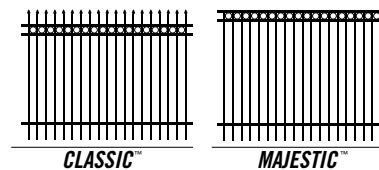

AEGIS PLUS® | 3-RAIL PANELS WITH RINGS | 6' PANEL LENGTH

STANDARD BOTTOM | 6' PANEL LENGTH (73.25" actual width) | 15 PICKETS PER PANEL | ASSEMBLY REQUIRED

PANEL	ITEM NUMBER	WEIGHT	STOCKING
3'	1 ☒ ⊗ 30346R	64 lbs	⊙
3.5'	1 ☒ ⊗ 30406R	68 lbs	⊙
4'	1 ☒ ⊗ 30466R	71 lbs	⊙
5'	1 ☒ ⊗ 30586R	78 lbs	⊙
6'	1 ☒ ⊗ 30706R	85 lbs	⊙
7'	1 ☒ ⊗ 30826R	92 lbs	⊙
8'	1 ☒ ⊗ 30946R	99 lbs	⊙

☒ = FENCE STYLES AVAILABLE | C = Classic M = Majestic G = Genesis W = Warrior

⊗ = COLOR OPTIONS AVAILABLE | B = Black N = Bronze W = White S = Sand

⊙ = NON-STOCKED PRODUCT

For details, see Ameristar's Sales Policy in the catalog guide.

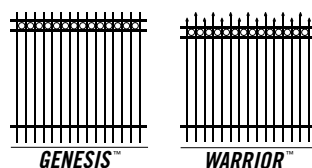
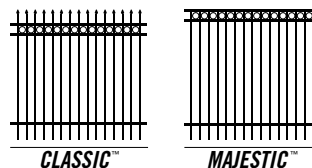

Effective: 01/05/21

AMERISTAR

ASSA ABLOY

TO PLACE YOUR ORDER CALL 888-333-3422 | VISIT AMERISTARFENCE.COM

AEGIS PLUS® | FASTENERS

AVAILABLE IN BOX QUANTITIES ONLY

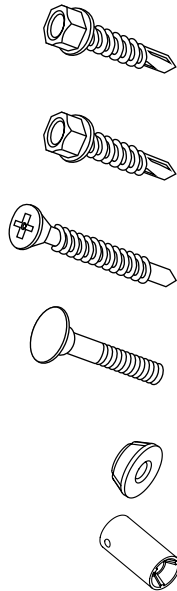

DESCRIPTION	ITEM NUMBER / BLACK	BAG QTY	WEIGHT EA
#14 x .75" Tek Screw <i>Steel hex head self-drilling screws for attaching Montage Plus brackets & adornments</i>	H⊗524P-50	50	.6 lbs
#10 x .625" Tek Screw <i>Steel hex head self-drilling screws for attaching Montage Plus brackets & adornments</i>	H⊗519P	1	.35 lbs
#10 x .75" Tek Screw <i>Steel flat head screws for setting angle on Montage Plus swivel brackets</i>	H⊗539P-50	50	.005 lbs
.25" x 2" Carriage Bolt <i>Steel carriage bolt for Montage Plus brackets</i>	H⊗516P	1	.027 lbs
.25" Tri Groove Security Nut	3-0033-⊠P-20	20	.3 lbs
Fastener Socket	6-0058PFG	1	.06 lbs
One-Way Screw Remover	88246P	1	.10 lbs

⊗ = COLOR OPTIONS AVAILABLE | **B** = Black **N** = Bronze

⊠ = COLOR OPTIONS AVAILABLE | **1** = Black **2** = Bronze

AEGIS PLUS® | FINIALS & ADORNMENTS

FINIALS & PICKET PLUGS FOR GENESIS PANELS ONLY | ADORNMENTS FOR 3-RAIL PANELS ONLY

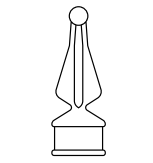

QUAD FLARE
 .75" / .60 lbs
 A⊗ 518

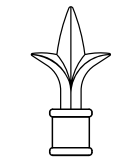

TRIAD
 .75" / .60 lbs
 A⊗ 520R

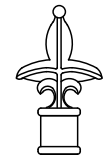

ROYALTY
 .75" / .21 lbs
 A⊗ 525

.75" PRESS FIT PICKET FINIALS

» 19 finials required per 8' panel

» 15 finials required per 6' panel

⊗ = COLOR OPTIONS AVAILABLE | **B** = Black **N** = Bronze
W = White **S** = Sand

NOTE: Picket plugs are available in bag quantities only / 19 plugs per bag.

Item number: PB7519P = **B** / PW7519P = **W**

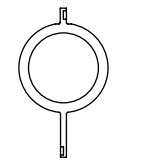

RINGS
 .75" / 12.5 lbs
 A⊗ 519

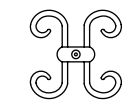

BUTTERFLY SCROLL
 .75" / 4 lbs
 H⊗ 506NR1

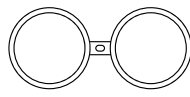

DOUBLE RING
 .75" / 14 lbs
 A⊗ 112

AEGIS PLUS PANEL ADORNMENTS

» #10 x .75" self-drilling screws included for
 H⊗506 & A⊗112

» A⊗519 = 18 per box | H⊗506 = 20 per box
 A⊗112 = 40 per box

⊗ = COLOR OPTIONS AVAILABLE | **B** = Black **N** = Bronze
W = White **S** = Sand

Effective: 01/05/21

AEGIS PLUS® | BRACKETS

AVAILABLE IN BAG QUANTITIES ONLY

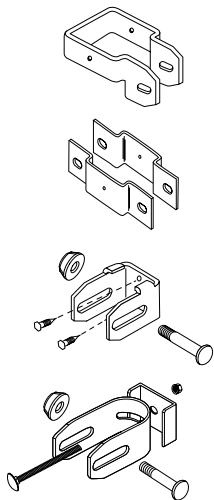

DESCRIPTION	SIZE	ITEM NUMBER	BAG QTY	BOX QTY	WEIGHT
Boulevard Bracket	2.5"	B⊗311SR	2	40 bags	.57 lbs
<i>Bags packaged with: #14 x .75" self-drilling screws .25" x 2" carriage bolts .25" tri groove security nuts</i>					
Line Bracket	2.5"	B⊗310SR	2	40 bags	.64 lbs
<i>Bags packaged with: .25" x 2" carriage bolts .25" tri groove security nuts</i>					
Flat Mount Bracket	n/a	B⊗306SR	2	75 bags	.34 lbs
<i>Bags packaged with: #14 x .75" self-drilling screws .25" x 2" carriage bolts .25" tri groove security nuts</i>					
Swivel Bracket	n/a	B⊗312SR	2	40 bags	1.0 lbs
<i>Bags packaged with: .3125" carriage bolt & nut .25" x 2" carriage bolts .25" tri groove security nuts</i>					

⊗ = COLOR OPTIONS AVAILABLE | **B** = Black **N** = Bronze **W** = White **S** = Sand

AEGIS PLUS® | CUSTOM FINISHES

WARRANTY ON CUT COMPONENTS VOID WITHOUT PROPER TOUCH-UP APPLICATION*

*For details & the guidelines for the proper 3-step process, see Ameristar's Sales Policy in the catalog guide

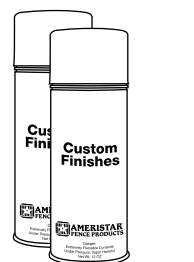
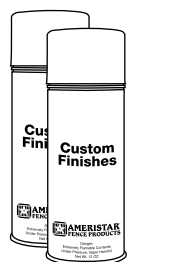
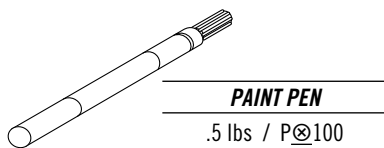

⊗ = COLOR OPTIONS AVAILABLE | **B** = Black **N** = Bronze **W** = White **S** = Sand

Effective: 01/05/21

AMERISTAR

ASSA ABLOY

TO PLACE YOUR ORDER CALL 888-333-3422 | VISIT AMERISTARFENCE.COM

AEGIS PLUS® | COMPONENTS

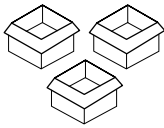
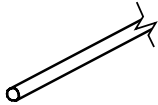
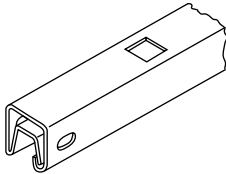
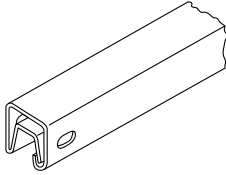
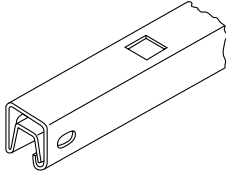

DESCRIPTION	PANEL HEIGHT	LENGTH	ITEM NUMBER	BOX QTY	WEIGHT
ForeRunner Rail / Through Punched	8'	92"	CⓧR18	4	14.2 lbs
	6'	73.25"	CⓧR16	6	11.4 lbs

Used for Classic, Genesis, Warrior & Majestic (not top rail) styles. Includes grommets & retaining rods.

ForeRunner Rail / Bottom Punched	8'	92"	MⓧR18	4	14.2 lbs
	6'	73.25"	MⓧR16	6	11.4 lbs

Used for Majestic style (top rail). Includes retaining rods.

ForeRunner Rail / Through Punched FOR RINGS	8'	92"	RⓧR18	4	14.2 lbs
	6'	73.25"	RⓧR16	6	11.4 lbs

Used for rail below ring adornments. Includes grommets & retaining rods.

Retaining Rods	71.375"	H532P	1	.25 lbs
	91.25"	H533P	1	.32 lbs

Galvanized over .125" diameter steel

Grommet Sets	.75" sq.	Xⓧ015P	15	3 oz.
	.75" sq.	Xⓧ019P	19	4 oz.

Available in bag quantities only.

ⓧ = COLOR OPTIONS AVAILABLE | **B** = Black | **N** = Bronze | **W** = White | **S** = Sand

Effective: 01/05/21

AEGIS PLUS® | STEEL SQUARE POSTS

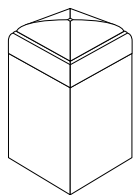

STEEL POSTS

	POST LENGTH	ITEM NUMBER	WEIGHT
2.5"sq. x 12ga.	5'	P⊗ 25060	16 lbs
	6'	P⊗ 25072	19 lbs
	7'	P⊗ 25084	22 lbs
	8'	P⊗ 25096	26 lbs
	9'	P⊗ 25108	28 lbs
	10'	P⊗ 25120	31 lbs
3"sq. x 12ga.	11'	P⊗ 25132	35 lbs
	12'	P⊗ 25144	36 lbs
	5'	P⊗ 30060	20 lbs
	6'	P⊗ 30072	24 lbs
	7'	P⊗ 30084	30 lbs
	8'	P⊗ 30096	34 lbs
4"sq. x 11ga.	9'	P⊗ 30108	39 lbs
	10'	P⊗ 30120	43 lbs
	11'	P⊗ 30132	47 lbs
	12'	P⊗ 30144	51 lbs
	6'	P⊗ 40072	39 lbs
	7'	P⊗ 40084	47 lbs
6"sq. x .1875" wall	8'	P⊗ 40096	54 lbs
	9'	P⊗ 40108	61 lbs
	10'	P⊗ 40120	67 lbs
	11'	P⊗ 40132	74 lbs
	12'	P⊗ 40144	81 lbs
	7'	P⊗ 60084	102 lbs
8"sq. x .25" wall	8'	P⊗ 60096	116 lbs
	9'	P⊗ 60108	131 lbs
	10'	P⊗ 60120	145 lbs
	11'	P⊗ 60132	160 lbs
8"sq. x .25" wall	12'	P⊗ 60144	174 lbs
	9'	P⊗ 80108	233 lbs
	10'	P⊗ 80120	259 lbs
	11'	P⊗ 80132	285 lbs
	12'	P⊗ 80144	311 lbs

⊗ = COLOR OPTIONS AVAILABLE | **B** = Black | **N** = Bronze | **W** = White | **S** = Sand

NOTE: When installed in a location subject to freezing, where posts are grouted into core-drilled holes, a .25" diameter hole should be drilled in the post approximately .5" above elevation to allow for drainage of built-up ground water. The drilled hole must be wiped clean and dry before applying Ameristar zinc primer and color finish.

Effective: 01/05/21

AMERISTAR

ASSA ABLOY

TO PLACE YOUR ORDER CALL 888-333-3422 | VISIT AMERISTARFENCE.COM

AEGIS PLUS® | STEEL PLATED SQUARE POSTS & POST CAPS

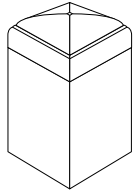

STEEL POSTS

	POST LENGTH	PLATE SIZE	ITEM NUMBER	WEIGHT
2.5"sq. x 12ga.	4'	5" sq. x .25" / .5625" holes (8833G)	P⊗ 25048P	16 lbs
	5'	5" sq. x .25" / .5625" holes (8833G)	P⊗ 25060P	19 lbs
	6'	5" sq. x .25" / .5625" holes (8833G)	P⊗ 25072P	22 lbs
	7'	5" sq. x .25" / .5625" holes (8833G)	P⊗ 25084P	26 lbs
	8'	5" sq. x .25" / .5625" holes (8833G)	P⊗ 25096P	28 lbs
	9'	5" sq. x .25" / .5625" holes (8833G)	P⊗ 25108P	31 lbs
	10'	5" sq. x .25" / .5625" holes (8833G)	P⊗ 25120P	34 lbs
3"sq. x 12ga.	4'	6" sq. x .25" / .5625" holes (5003G)	P⊗ 30048P	20 lbs
	5'	6" sq. x .25" / .5625" holes (5003G)	P⊗ 30060P	24 lbs
	6'	6" sq. x .25" / .5625" holes (5003G)	P⊗ 30072P	30 lbs
	7'	6" sq. x .25" / .5625" holes (5003G)	P⊗ 30084P	34 lbs
	8'	6" sq. x .25" / .5625" holes (5003G)	P⊗ 30096P	39 lbs
	9'	6" sq. x .25" / .5625" holes (5003G)	P⊗ 30108P	43 lbs
	10'	6" sq. x .25" / .5625" holes (5003G)	P⊗ 30120P	47 lbs
4"sq. x 11ga.	4'	8" sq. x .375" / .5625" holes (8876G)	P⊗ 40048P	33 lbs
	5'	8" sq. x .375" / .5625" holes (8876G)	P⊗ 40060P	39 lbs
	6'	8" sq. x .375" / .5625" holes (8876G)	P⊗ 40072P	47 lbs
	7'	8" sq. x .375" / .5625" holes (8876G)	P⊗ 40084P	54 lbs
	8'	8" sq. x .375" / .5625" holes (8876G)	P⊗ 40096P	61 lbs
	9'	8" sq. x .375" / .5625" holes (8876G)	P⊗ 40108P	67 lbs
	10'	8" sq. x .375" / .5625" holes (8876G)	P⊗ 40120P	74 lbs

⊗ = COLOR OPTIONS AVAILABLE | **B** = Black **N** = Bronze **W** = White **S** = Sand

NOTE: Posts used with Majestic may require an additional 1" longer than the panel or gate height, depending on the grade elevation.

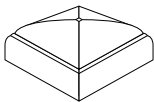

STANDARD FLAT CAP
Steel

CAP SIZE	ITEM NUMBER	WEIGHT
2.5"sq.	A⊗ 507	.3 lbs
3"sq.	A⊗ 508	.3 lbs
4"sq.	A⊗ 509	.4 lbs
6"sq.	A⊗ 515	.8 lbs
8"sq.	A⊗ 801	.2 lbs



BALL CAP
Aluminum

CAP SIZE	ITEM NUMBER	WEIGHT
2.5"sq.	A⊗ 513R1	.7 lbs
3"sq.	A⊗ 516R1	.8 lbs
4"sq.	A⊗ 517	2 lbs
6"sq.	A⊗ 521	8 lbs

Effective: 01/05/21

AEGIS PLUS® | CONSTRUCTION SPECIFICATION 32 31 19

COMMERCIAL STEEL ORNAMENTAL FENCE SYSTEM – INTERNALLY SECURED

PART 1 - GENERAL

1.01 WORK INCLUDED

The contractor shall provide all labor, materials and appurtenances necessary for installation of the residential ornamental steel fence system defined herein at (*specify project site*).

1.02 RELATED WORK

Section ___ - Earthwork

Section ___ - Concrete

1.03 SYSTEM DESCRIPTION

The manufacturer shall supply a total commercial ornamental steel fence system of the Ameristar® Aegis Plus® (*specify Classic™, Majestic™, Genesis™ or Warrior™*) design. The system shall include all components (*i.e., pickets, rails, posts, gates and hardware*) required.

1.04 QUALITY ASSURANCE

The contractor shall provide laborers and supervisors who are thoroughly familiar with the type of construction involved and materials and techniques specified.

1.05 REFERENCES

- **ASTM A653/A653M** – Standard Specification for Steel Sheet, Zinc-Coated (*Galvanized*) or Zinc-Iron Alloy Coated (*Galvannealed*) by the Hot-Dip Process
- **ASTM B117** – Practice for Operating Salt-Spray (*Fog*) Apparatus
- **ASTM D523** – Test Method for Specular Gloss
- **ASTM D714** – Test Method for Evaluating Degree of Blistering in Paint
- **ASTM D1654** – Test Method for Evaluation of Painted or Coated Specimens Subjected to Corrosive Environments
- **ASTM D2244** – Test Method for Calculation of Color Differences from Instrumentally Measured Color Coordinates
- **ASTM D2794** – Test Method for Resistance of Organic Coatings to the Effects of Rapid Deformation (Impact)
- **ASTM D3359** – Test Method for Measuring Adhesion by Tape Test
- **ASTM D6695** – Standard Practice for Xenon-Arc Exposures of Paint and Related Coatings
- **ASTM F2408** – Ornamental Fences Employing Galvanized Steel Tubular Pickets

1.06 SUBMITTAL

The manufacturer's submittal package shall be provided prior to installation.

1.07 PRODUCT HANDLING AND STORAGE

Upon receipt at the job site, all materials shall be checked to ensure that no damages occurred during shipping or handling. Materials shall be stored in such a manner to ensure proper ventilation and drainage, and to protect against damage, weather, vandalism and theft.

1.08 PRODUCT WARRANTY

- A. All structural fence components (*i.e. rails, pickets, and posts*) shall be warranted within specified limitations, by the manufacturer for a period of 10 years from date of original purchase. Warranty shall cover any defects in material finish, including cracking, peeling, chipping, blistering or corroding.
- B. Reimbursement for labor necessary to restore or replace components that have been found to be defective under the terms of manufacturer's warranty shall be guaranteed for five (5) years from date of original purchase.

PART 2 - MATERIALS

2.01 MANUFACTURER

The commercial ornamental steel fence system shall conform to Ameristar Aegis Plus, (*specify Classic, Majestic, Genesis, or Warrior*) (*specify 2-Rail, 3-Rail or 3-Rail with Rings*) style manufactured by Ameristar Fence Products, Inc. in Tulsa, Oklahoma.

2.02 MATERIAL

- A. Steel material for fence framework (*i.e. tubular pickets, rails and posts*), when galvanized prior to forming, shall conform to the requirements of **ASTM A924/A924M**, with a minimum yield strength of 45,000 psi (310 MPa). The steel shall be hot-dip galvanized to meet the requirements of **ASTM A653/A653M** with a minimum zinc coating weight of 0.60 oz/ft² (276 g/m²), Coating Designation G-60.
- B. Material for fence pickets shall be .75" square x 17 Ga. tubing. The cross-sectional shape of the rails shall conform to the manufacturer's ForeRunner™ double-wall design with outside cross-section dimensions of 1.50" square and a minimum thickness of 14 Ga. Picket holes in the ForeRunner rail shall be spaced 4.70" o.c. Picket retaining rods shall be 0.125" diameter galvanized steel. High quality PVC grommets shall be supplied to seal all picket-to-rail intersections. Fence posts and gate posts shall meet the minimum size requirements of **Table 1**.

2.03 FABRICATION

- A. Pickets, rails and posts shall be pre-cut to specified lengths. ForeRunner rails shall be pre-punched to accept pickets.

Effective: 01/05/21

AMERISTAR

ASSA ABLOY

TO PLACE YOUR ORDER CALL 888-333-3422

VISIT AMERISTARFENCE.COM

AEGIS PLUS® | CONSTRUCTION SPECIFICATION 32 31 19

COMMERCIAL STEEL ORNAMENTAL FENCE SYSTEM – INTERNALLY SECURED

- B. Grommets shall be inserted into the pre-punched holes in the rails and pickets shall be inserted through the grommets so that pre-drilled picket holes align with the internal upper raceway of the ForeRunner rails (Note: This can best be accomplished by using an alignment template). Retaining rods shall be inserted into each ForeRunner rail so that they pass through the pre-drilled holes in each picket, thus completing the panel assembly.
- C. The manufactured galvanized framework shall be subjected to the PermaCoat® thermal stratification coating process (*high-temperature, in-line, multi-stage pretreatment/wash*, an electrostatic spray application of any epoxy base, and a separate electrostatic spray application of a polyester finish. The base coat shall be a thermosetting epoxy powder coating (*gray in color*) with a minimum thickness of 2 mils (0.0508mm). The topcoat shall be a “no-mar” TGIC polyester powder coat finish with a minimum thickness of 2 mils (0.0508mm). The color shall be (*specify Black, Bronze, White or Desert Sand*). The stratification-coated framework shall be capable of meeting the performance requirements for each quality characteristic shown in **Table 2**.
- D. Completed panels shall be capable of supporting a 400 lb. load (*applied at midspan*) without permanent deformation. Panels without rings shall be biasable to a 12.5% change in grade.
- E. Swing gates shall be fabricated using 1.5" x 14ga. Forerunner double channel rail, 1.75" sq. x 14ga. gate ends, and 3/4" sq. x 17ga. pickets. Gates that exceed 6' in width will have a 1.5" sq. x 14ga. intermediate upright. All rail and upright intersections shall be joined by welding. All picket and rail intersections shall also be joined by welding.

PART 3 - EXECUTION

3.01 PREPARATION

All new installation shall be laid out by the contractor in accordance with the construction plans.

3.02 FENCE INSTALLATION

Fence post shall be spaced according to **Table 3**, plus or minus .5". For installations that must be raked to follow sloping grades, the post spacing dimension must be

measured along the grade. Fence panels shall be attached to posts with brackets supplied by the manufacturer. Posts shall be set in concrete footers having a minimum depth of 36" (*Note: In some cases, local restrictions of freezing weather conditions may require a greater depth*). The "Earthwork" and "Concrete" sections of this specification shall govern material requirements for the concrete footer. Posts setting by other methods such as plated posts or grouted core-drilled footers are permissible only if shown by engineering analysis to be sufficient in strength for the intended application.

3.03 FENCE INSTALLATION MAINTENANCE

When cutting/drilling rails or posts adhere to the following steps to seal the exposed steel surfaces; 1) Remove all metal shavings from cut area. 2) Apply zinc-rich primer to thoroughly cover cut edge and/or drilled hole; let dry. 3) Apply 2 coats of custom finish paint matching fence color. Failure to seal exposed surfaces per steps 1-3 above will negate warranty. Ameristar spray cans or paint pens shall be used to prime and finish exposed surfaces; it is recommended that paint pens be used to prevent overspray. Use of non-Ameristar parts or components will negate the manufacturer's warranty.

3.04 GATE INSTALLATION

Gate posts shall be spaced according to the manufacturer's gate drawings, dependent on standard out-to-out gate leaf dimensions and gate hardware selected. Type and quantity of gate hinges shall be based on the application; weight, height, and number of gate cycles. The manufacturer's gate drawings shall identify the necessary gate hardware required for the application. Gate hardware shall be provided by the manufacture of the gate and shall be installed per manufacturer's recommendations.

3.05 CLEANING

The contractor shall clean the jobsite of excess materials; post-hole excavations shall be scattered uniformly away from posts.

SEE REFERENCED TABLES ON THE FOLLOWING PAGE

Effective: 01/05/21

AEGIS PLUS® | CONSTRUCTION SPECIFICATION 32 31 19

COMMERCIAL STEEL ORNAMENTAL FENCE SYSTEM – INTERNALLY SECURED

TABLE 1

MINIMUM SIZES FOR AEGIS PLUS POSTS		
FENCE POSTS	PANEL HEIGHTS	
2.5" x 12 ga.	up to and including 6' height	
3" x 12 ga.	over 6' and including 8' height	
GATE LEAF	GATE HEIGHT	
	up to & including 6'	Over 6' to 8'
up to 4'	2.5" x 12 gauge	3" x 12 gauge
4'1" to 6'	3" x 12 gauge	3" x 12 gauge
6'1" to 8'	4" x 11 gauge	4" x 11 gauge
8'1" to 10'	4" x 11 gauge	6" x 3/16"
10'1" to 12'	6" x 3/16"	6" x 3/16"
12'1" to 16'	6" x 3/16"	6" x 3/16"

TABLE 2

COATING PERFORMANCE REQUIREMENTS								
QUALITY CHARACTERISTICS	ASTM TEST METHOD	PERFORMANCE REQUIREMENTS						
ADHESION	D3359 – METHOD B	Adhesion (<i>retention of coating</i>) over 90% of test area (<i>tape and knife kit test</i>).						
CORROSION RESISTANCE	B117, D714, D1654	Corrosion resistance over 3,500 hours (<i>scribed per D1654; failure mode is accumulation of 1/8" coating loss from scribe or medium #8 blisters</i>)						
IMPACT RESISTANCE	D2794	Impact resistance over 60" lb. (<i>forward impact using 0.625" ball</i>).						
WEATHERING RESISTANCE	D822 D2244, D523 (60° method)	Weathering resistance over 1,000 hours (<i>failure mode is 60% loss of gloss or color variance of more than 3 delta-E color units</i>).						
AEGIS PLUS POST SPACING BY BRACKET TYPE								
SPAN	8' / 6' nominal (92" / 73.25" rails)							
POST SIZE	2.5"	3"	2.5"	3"	2.5"	3"	2.5"	3"
BRACKET TYPE	Commercial Universal Blvd. (BB311)		Commercial Line Blvd. (BB310)		Commercial Flat Mount (BB306)		Commercial Swivel (BB312)*	
POST SETTINGS ± .5" O.C.	95.5" / 76.75"	96" / 77.25"	95.5" / 76.75"	96" / 77.25"	95.5" / 76.75"	96" / 77.25"	*97" / *78.25"	*97.5" / *78.75"

TABLE 3

*When using BB312 swivel brackets on either or both ends of a panel installation, care must be taken to ensure the spacing between post and adjoining pickets meets applicable codes. This will require trimming one or both ends of the panel.

Effective: 01/05/21

AMERISTAR

ASSA ABLOY

TO PLACE YOUR ORDER CALL 888-333-3422 | VISIT AMERISTARFENCE.COM

AEGIS PLUS® | LIMITED WARRANTY

COMMERCIAL STEEL ORNAMENTAL FENCE SYSTEM – INTERNALLY SECURED

Aegis Plus® Commercial Steel Ornamental Fence System by Ameristar® is manufactured from the highest quality materials by skilled craftsmen to meet the highest standards of workmanship in the industry. Galvanized steel framework shall be subject to a six stage pretreatment/wash, followed by an electrostatic spray application of PermaCoat® Color System, a two coat powder system. The base coat is a thermosetting epoxy powder coating (*gray in color*). The top coat is a “no-mar” TGIC polyester powder coat finish, which provides the protection necessary to withstand adverse environmental conditions.

The powder coated surface on all framework (*i.e., pickets, rails and posts*) by Ameristar is guaranteed under normal and proper usage, against cracking, peeling, chipping, blistering or corroding for a period of ten (10) years from the original purchase date. Normal and proper usage does not include physical damage, abrasion or exposure to salty environments to the protective coating.

Aegis Plus Commercial Steel Ornamental Fence System framework is also guaranteed for the same period of time against defects in workmanship or materials.

Should any ornamental fence framework manufactured by Ameristar Fence Products fail in accordance with any of the above conditions, Ameristar Fence Products warrants to the original purchaser their redemption through replacement, renewal or issuance of a pro-rated credit. The decision as to which method of redemption is allowed is solely at the discretion of Ameristar. If pro-rated allowance is the chosen alternative, the amount will be based on the total number of years under warranty from date of purchase to date of claim, based on the original cost of framing materials found to be defective. Notice of failure under the conditions of this warranty shall be sent to Ameristar Fence Products or its authorized representative, in writing, together with proof of purchase and shall specify the nature of the defect and when it was first observed. When cutting Aegis Plus components immediately seal the exposed surfaces by 1) Removing all metal shavings from cut area 2) Apply zinc-rich primer to thoroughly cover cut edge and drilled hole; let dry 3) Apply 2 coats of custom finish paint matching fence color. Failure to seal exposed surfaces per steps 1-3 above will negate warranty. If the contractor uses non Ameristar parts / components this will negate the warranty. Should the fence be improperly installed, Ameristar Fence Products shall not be responsible for guaranteed performance or appearance of the material. Neither does this guarantee apply when failure or damage is due to improper use or application, abuse or misuse, salty environments, vandalism or acts of God. Ameristar Fence Products reserves the right to inspect the material to determine validity of the claim.

Upon validation of the claim by Ameristar Fence Products or its authorized representative, redemption by replacement, renewal or issuance of a pro-rated credit shall be made by Ameristar Fence Products. Reimbursement for labor necessary to restore and/or replace components that have been found defective under the terms of this warranty is guaranteed to the original purchaser for a period of five (5) years from the original purchase date. Ameristar reserves the right to select the qualified company or individual to perform the labor to repair or replace the components that are deemed to be defective under the terms of this warranty.

The above constitutes the complete warranty by the manufacturer. No other agreement, written or implied, is valid. Ameristar Fence Products does not authorize any other person or agent to make any other express warranties. Ameristar Fence Products neither assumes nor authorizes any other person or agent to assume any other liability in connection with Aegis Plus Commercial Steel Ornamental Fence System. Some jurisdictions do not allow limitations on how long an implied warranty lasts, nor do they allow an exclusion or limitation of incidental or consequential damages; therefore, the limitations and exclusions noted herein may not apply.

Effective: 01/05/21

AEGIS PLUS® | SINGLE SWING GATE SPECIFICATIONS

1.75"sq x 14ga STEEL GATE ENDS | 1.25" ForeRunner™ RAILS | .75"sq x 17ga PICKETS | 3.5' - 16' NOMINAL OPENINGS

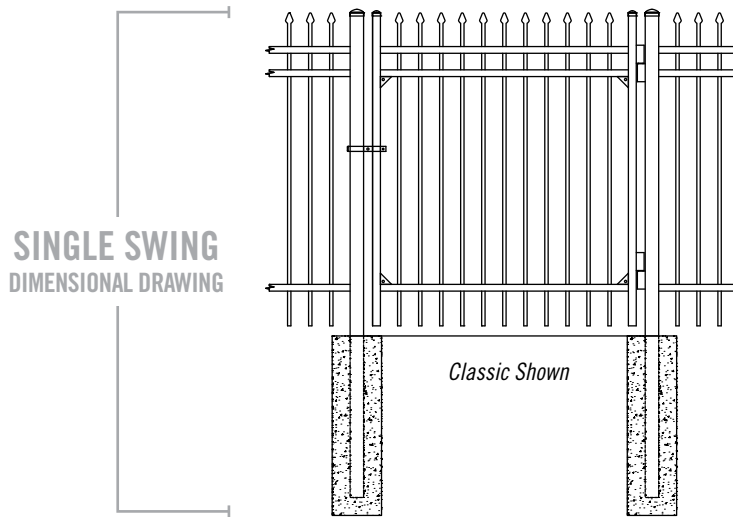

SINGLE SWING
HARDWARE KITS & POST
INTERSPACES

OPENING	LEAF WIDTH*	SGBSX25 / SGBSX3 FORK LATCH / BOX HINGE KITS			CGBS-25 CGBS-3 / CGBS-4 COMMERCIAL HINGE KITS			HGBS-25 HGBS-3 / HGBS-4 HEAVY COMMERCIAL HINGE KITS		
		HC	LC	P _S	HC	LC	P _S	HC	LC	P _S
3.5'	40"	2"	2"	44"	1"	3"	44"	1.25"	3"	44.25"
4'	49.5"	2"	2"	53.5"	1"	3"	53.5"	1.25"	3"	53.75"
5'	58.75"	2"	2"	62.75"	1"	3"	62.75"	1.25"	3"	63"
6'	68"	2"	2"	72"	1"	3"	72"	1.25"	3"	72.25"
7'	86.75"	2"	2"	90.75"	1"	3"	90.75"	1.25"	3"	91"
8'	95.5"	2"	2"	99.5"	1"	3"	99.5"	1.25"	3"	99.75"
9'	105.5"	2"	2"	109.5"	1"	3"	109.5"	1.25"	3"	109.75"
10'	114.75"	2"	2"	118.75"	1"	3"	118.75"	1.25"	3"	119"
11'	133.5"	2"	2"	137.5"	1"	3"	137.5"	1.25"	3"	137.75"
12'	143"	2"	2"	147"	1"	3"	147"	1.25"	3"	147.25"
13'	152.25"	2"	2"	156.25"	1"	3"	156.25"	1.25"	3"	156.5"
14'	171"	2"	2"	175"	1"	3"	175"	1.25"	3"	175.25"
15'	180.25"	2"	2"	184.25"	1"	3"	184.25"	1.25"	3"	184.5"
16'	189.75"	2"	2"	193.75"	1"	3"	193.75"	1.25"	3"	194"

W = width* | HC = hinge clearance | LC = latch clearance | P_S = gate post spacing**
* From outside to outside | ** From inside to inside

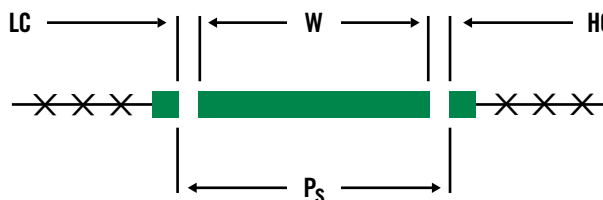

Effective: 01/05/21

AMERISTAR

ASSA ABLOY

TO PLACE YOUR ORDER CALL 888-333-3422 | VISIT AMERISTARFENCE.COM

AEGIS PLUS® | DOUBLE SWING GATE SPECIFICATIONS

1.75"sq x 14ga STEEL GATE ENDS | 1.25" ForeRunner™ RAILS | .75"sq x 17ga PICKETS | 7' - 32' NOMINAL OPENINGS

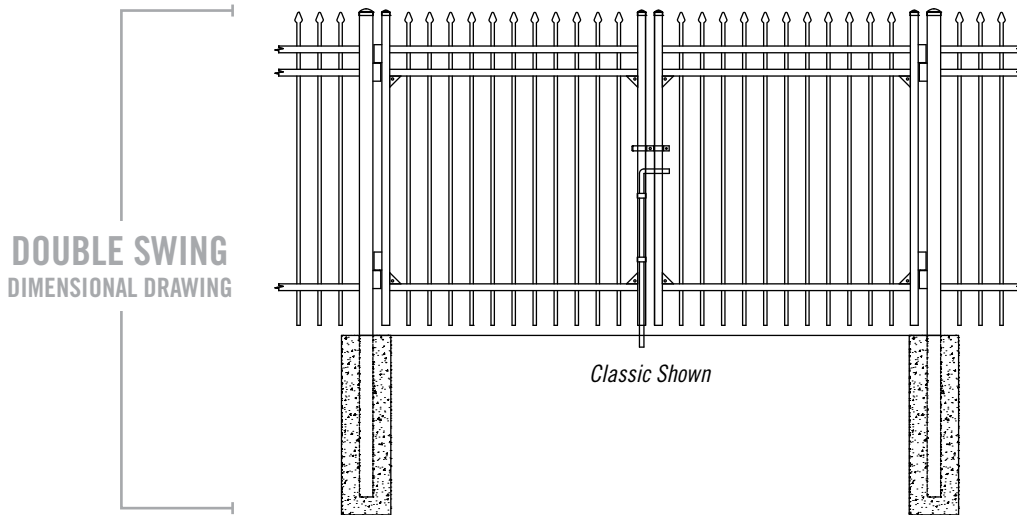

DOUBLE SWING HARDWARE KITS & POST INTERSPACES

OPENING	LEAF WIDTH*	SGBDX BOX HINGE KITS			HGBD COMMERCIAL HINGE KITS		
		HC	LC	P _d	HC	LC	P _d
7'	40"	2"	2"	86"	2.375"	3"	84.5"
8'	49.5"	2"	2"	105"	2.375"	3"	103.5"
10'	58.75"	2"	2"	123.5"	2.375"	3"	122"
12'	68"	2"	2"	142"	2.375"	3"	140.5"
14'	86.75"	2"	2"	179.5"	2.375"	3"	178"
16'	95.5"	2"	2"	197"	2.375"	3"	195.5"
18'	105.5"	2"	2"	217"	2.375"	3"	215.5"
20'	114.75"	2"	2"	235.5"	2.375"	3"	234"
22'	133.5"	2"	2"	273"	2.375"	3"	271.5"
24'	143"	2"	2"	292"	2.375"	3"	290.5"
26'	152.25"	2"	2"	310.5"	2.375"	3"	309"
28'	171"	2"	2"	348"	2.375"	3"	346.5"
30'	180.25"	2"	2"	366.5"	2.375"	3"	365"
32'	189.75"	2"	2"	385.5"	2.375"	3"	384"



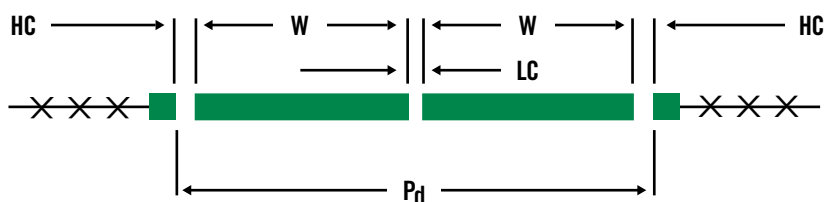

































W = width (x2)* | HC = hinge clearance (x2) | LC = latch clearance
 P_d = gate post spacing**
 * From outside to outside | ** From inside to inside



Effective: 01/05/21

AEGIS PLUS® | 2-RAIL SWING GATES

4" AIR GAP | STANDARD BOTTOM | GATE HARDWARE SOLD SEPARATELY

	OPENING	LEAF WIDTH	ITEM NUMBER	PICKET QTY	WEIGHT	STOCKING
3' HEIGHT	3.5'	40"	1  234-42	7	40 lbs	⊙
	4'	49.5"	1  234-48	9	46 lbs	⊙
	5'	58.75"	1  234-60	11	57 lbs	⊙
	6'	68"	1  234-72	13	65 lbs	⊙
	7'	86.75"	1  234-84	17	74 lbs	⊙
	8'	95.5"	1  234-96	19	84 lbs	⊙
	9'	105.5"	1  234-108	21	93 lbs	⊙
	10'	114.75"	1  234-120	23	102 lbs	⊙
	11'	133.5"	1  234-132	27	115 lbs	⊙
	12'	143"	1  234-144	29	129 lbs	⊙
	13'	152.25"	1  234-156	31	140 lbs	⊙
	14'	171"	1  234-168	35	148 lbs	⊙
3.5' HEIGHT	15'	180.25"	1  234-180	37	156 lbs	⊙
	16'	189.75"	1  234-192	39	167 lbs	⊙
	3.5'	40"	1  240-42	7	45 lbs	⊙
	4'	49.5"	1  240-48	9	52 lbs	⊙
	5'	58.75"	1  240-60	11	64 lbs	⊙
	6'	68"	1  240-72	13	72 lbs	⊙
	7'	86.75"	1  240-84	17	81 lbs	⊙
	8'	95.5"	1  240-96	19	92 lbs	⊙
	9'	105.5"	1  240-108	21	102 lbs	⊙
	10'	114.75"	1  240-120	23	112 lbs	⊙
	11'	133.5"	1  240-132	27	127 lbs	⊙
	4' HEIGHT	12'	143"	1  240-144	29	142 lbs
13'		152.25"	1  240-156	31	153 lbs	⊙
14'		171"	1  240-168	35	162 lbs	⊙
15'		180.25"	1  240-180	37	171 lbs	⊙
16'		189.75"	1  240-192	39	182 lbs	⊙
3.5'		40"	1  246-42	7	49 lbs	⊙
4'		49.5"	1  246-48	9	57 lbs	⊙
5'		58.75"	1  246-60	11	71 lbs	⊙
6'		68"	1  246-72	13	78 lbs	⊙
7'		86.75"	1  246-84	17	88 lbs	⊙
8'	95.5"	1  246-96	19	99 lbs	⊙	
9'	105.5"	1  246-108	21	110 lbs	⊙	
10'	114.75"	1  246-120	23	121 lbs	⊙	

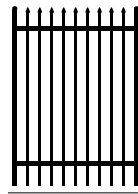

CLASSIC™

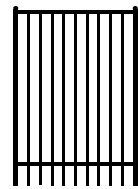

MAJESTIC™

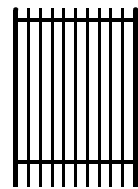

GENESIS™

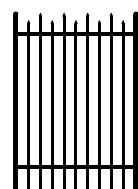

WARRIOR™

ADDITIONAL 4', 5' & 6' HEIGHTS CONTINUED ON NEXT PAGE

Effective: 01/05/21

AMERISTAR

ASSA ABLOY

TO PLACE YOUR ORDER CALL 888-333-3422 | VISIT AMERISTARFENCE.COM

AEGIS PLUS® | 2-RAIL SWING GATES

4" AIR GAP | STANDARD BOTTOM | GATE HARDWARE SOLD SEPARATELY

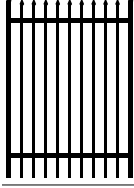
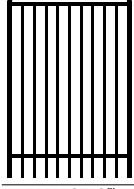
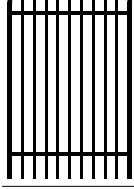
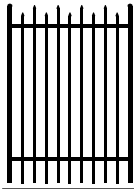
	OPENING	LEAF WIDTH	ITEM NUMBER	PICKET QTY	WEIGHT	STOCKING		
4' HEIGHT	11'	133.5"	1☒☉246-132	27	138 lbs	☉	 CLASSIC™	
	12'	143"	1☒☉246-144	29	155 lbs	☉		
	13'	152.25"	1☒☉246-156	31	166 lbs	☉		
	14'	171"	1☒☉246-168	35	176 lbs	☉		
	15'	180.25"	1☒☉246-180	37	186 lbs	☉		
	16'	189.75"	1☒☉246-192	39	197 lbs	☉		
5' HEIGHT	3.5'	40"	1☒☉258-42	7	58 lbs	☉	 MAJESTIC™	
	4'	49.5"	1☒☉258-48	9	68 lbs	☉		
	5'	58.75"	1☒☉258-60	11	85 lbs	☉		
	6'	68"	1☒☉258-72	13	91 lbs	☉		
	7'	86.75"	1☒☉258-84	17	102 lbs	☉		
	8'	95.5"	1☒☉258-96	19	114 lbs	☉		
	9'	105.5"	1☒☉258-108	21	127 lbs	☉		
	10'	114.75"	1☒☉258-120	23	140 lbs	☉		
	11'	133.5"	1☒☉258-132	27	161 lbs	☉		
	12'	143"	1☒☉258-144	29	181 lbs	☉		
6' HEIGHT	13'	152.25"	1☒☉258-156	31	192 lbs	☉	 GENESIS™	
	14'	171"	1☒☉258-168	35	204 lbs	☉		
	15'	180.25"	1☒☉258-180	37	216 lbs	☉		
	16'	189.75"	1☒☉258-192	39	227 lbs	☉		
	3.5'	40"	1☒☉270-42	7	68 lbs	☉		 WARRIOR™
	4'	49.5"	1☒☉270-48	9	78 lbs	☉		
	5'	58.75"	1☒☉270-60	11	98 lbs	☉		
	6'	68"	1☒☉270-72	13	103 lbs	☉		
	7'	86.75"	1☒☉270-84	17	117 lbs	☉		
	8'	95.5"	1☒☉270-96	19	129 lbs	☉		
9'	105.5"	1☒☉270-108	21	144 lbs	☉			
10'	114.75"	1☒☉270-120	23	159 lbs	☉			
11'	133.5"	1☒☉270-132	27	183 lbs	☉			
12'	143"	1☒☉270-144	29	206 lbs	☉			
13'	152.25"	1☒☉270-156	31	220 lbs	☉			
14'	171"	1☒☉270-168	35	233 lbs	☉			
15'	180.25"	1☒☉270-180	37	246 lbs	☉			
16'	189.75"	1☒☉270-192	39	258 lbs	☉			

☒ = FENCE STYLES AVAILABLE | C = Classic M = Majestic G = Genesis W = Warrior

☉ = COLOR OPTIONS AVAILABLE | B = Black N = Bronze W = White S = Sand

☉ = NON-STOCKED PRODUCT

For details, see Ameristar's Sales Policy in the catalog guide.

Effective: 01/05/21

AEGIS PLUS® | 3-RAIL SWING GATES

4" AIR GAP | STANDARD BOTTOM | GATE HARDWARE SOLD SEPARATELY

	OPENING	LEAF WIDTH	ITEM NUMBER	PICKET QTY	WEIGHT	STOCKING
3' HEIGHT	3.5'	40"	1 <input checked="" type="checkbox"/> <input checked="" type="checkbox"/> 334-42	7	48 lbs	⊙
	4'	49.5"	1 <input checked="" type="checkbox"/> <input checked="" type="checkbox"/> 334-48	9	57 lbs	⊙
	5'	58.75"	1 <input checked="" type="checkbox"/> <input checked="" type="checkbox"/> 334-60	11	72 lbs	⊙
	6'	68"	1 <input checked="" type="checkbox"/> <input checked="" type="checkbox"/> 334-72	13	79 lbs	⊙
	7'	86.75"	1 <input checked="" type="checkbox"/> <input checked="" type="checkbox"/> 334-84	17	88 lbs	⊙
	8'	95.5"	1 <input checked="" type="checkbox"/> <input checked="" type="checkbox"/> 334-96	19	101 lbs	⊙
	9'	105.5"	1 <input checked="" type="checkbox"/> <input checked="" type="checkbox"/> 334-108	21	108 lbs	⊙
	10'	114.75"	1 <input checked="" type="checkbox"/> <input checked="" type="checkbox"/> 334-120	23	124 lbs	⊙
	11'	133.5"	1 <input checked="" type="checkbox"/> <input checked="" type="checkbox"/> 334-132	27	139 lbs	⊙
	12'	143"	1 <input checked="" type="checkbox"/> <input checked="" type="checkbox"/> 334-144	29	154 lbs	⊙
	13'	152.25"	1 <input checked="" type="checkbox"/> <input checked="" type="checkbox"/> 334-156	31	166 lbs	⊙
	14'	171"	1 <input checked="" type="checkbox"/> <input checked="" type="checkbox"/> 334-168	35	177 lbs	⊙
	15'	180.25"	1 <input checked="" type="checkbox"/> <input checked="" type="checkbox"/> 334-180	37	189 lbs	⊙
16'	189.75"	1 <input checked="" type="checkbox"/> <input checked="" type="checkbox"/> 334-192	39	202 lbs	⊙	
3.5' HEIGHT	3.5'	40"	1 <input checked="" type="checkbox"/> <input checked="" type="checkbox"/> 340-42	7	53 lbs	⊙
	4'	49.5"	1 <input checked="" type="checkbox"/> <input checked="" type="checkbox"/> 340-48	9	62 lbs	⊙
	5'	58.75"	1 <input checked="" type="checkbox"/> <input checked="" type="checkbox"/> 340-60	11	78 lbs	⊙
	6'	68"	1 <input checked="" type="checkbox"/> <input checked="" type="checkbox"/> 340-72	13	85 lbs	⊙
	7'	86.75"	1 <input checked="" type="checkbox"/> <input checked="" type="checkbox"/> 340-84	17	96 lbs	⊙
	8'	95.5"	1 <input checked="" type="checkbox"/> <input checked="" type="checkbox"/> 340-96	19	109 lbs	⊙
	9'	105.5"	1 <input checked="" type="checkbox"/> <input checked="" type="checkbox"/> 340-108	21	116 lbs	⊙
	10'	114.75"	1 <input checked="" type="checkbox"/> <input checked="" type="checkbox"/> 340-120	23	134 lbs	⊙
	11'	133.5"	1 <input checked="" type="checkbox"/> <input checked="" type="checkbox"/> 340-132	27	151 lbs	⊙
	12'	143"	1 <input checked="" type="checkbox"/> <input checked="" type="checkbox"/> 340-144	29	168 lbs	⊙
	13'	152.25"	1 <input checked="" type="checkbox"/> <input checked="" type="checkbox"/> 340-156	31	180 lbs	⊙
	14'	171"	1 <input checked="" type="checkbox"/> <input checked="" type="checkbox"/> 340-168	35	192 lbs	⊙
	15'	180.25"	1 <input checked="" type="checkbox"/> <input checked="" type="checkbox"/> 340-180	37	204 lbs	⊙
16'	189.75"	1 <input checked="" type="checkbox"/> <input checked="" type="checkbox"/> 340-192	39	217 lbs	⊙	

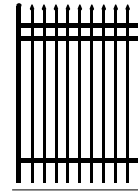

CLASSIC™

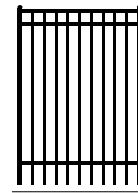

MAJESTIC™

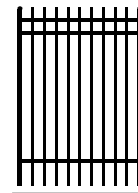

GENESIS™

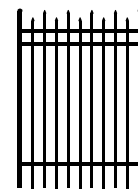

WARRIOR™

4', 5', 6', 7' & 8' HEIGHTS CONTINUED ON NEXT PAGES

= FENCE STYLES AVAILABLE | **C** = Classic **M** = Majestic **G** = Genesis **W** = Warrior

= COLOR OPTIONS AVAILABLE | **B** = Black **N** = Bronze **W** = White **S** = Sand

⊙ = NON-STOCKED PRODUCT

For details, see Ameristar's Sales Policy in the catalog guide.

Effective: 01/05/21

AMERISTAR

ASSA ABLOY

TO PLACE YOUR ORDER CALL 888-333-3422 | VISIT AMERISTARFENCE.COM

AEGIS PLUS® | 3-RAIL SWING GATES

4" AIR GAP | STANDARD BOTTOM | GATE HARDWARE SOLD SEPARATELY

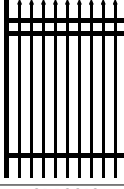
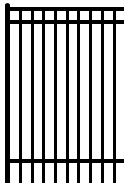
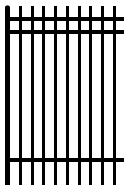
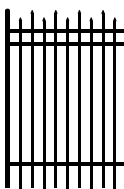
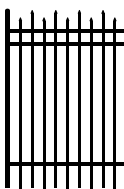
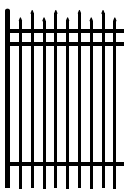
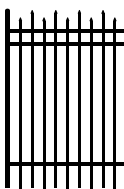
	OPENING	LEAF WIDTH	ITEM NUMBER	PICKET QTY	WEIGHT	STOCKING	
4' HEIGHT	3.5'	40"	1 <input checked="" type="checkbox"/> <input type="checkbox"/> 346-42	7	57 lbs	<input type="checkbox"/>	 CLASSIC™
	4'	49.5"	1 <input checked="" type="checkbox"/> <input type="checkbox"/> 346-48	9	67 lbs	<input type="checkbox"/>	
	5'	58.75"	1 <input checked="" type="checkbox"/> <input type="checkbox"/> 346-60	11	84 lbs	<input type="checkbox"/>	
	6'	68"	1 <input checked="" type="checkbox"/> <input type="checkbox"/> 346-72	13	91 lbs	<input type="checkbox"/>	
	7'	86.75"	1 <input checked="" type="checkbox"/> <input type="checkbox"/> 346-84	17	103 lbs	<input type="checkbox"/>	 MAJESTIC™
	8'	95.5"	1 <input checked="" type="checkbox"/> <input type="checkbox"/> 346-96	19	116 lbs	<input type="checkbox"/>	
	9'	105.5"	1 <input checked="" type="checkbox"/> <input type="checkbox"/> 346-108	21	130 lbs	<input type="checkbox"/>	
	10'	114.75"	1 <input checked="" type="checkbox"/> <input type="checkbox"/> 346-120	23	143 lbs	<input type="checkbox"/>	
	11'	133.5"	1 <input checked="" type="checkbox"/> <input type="checkbox"/> 346-132	27	162 lbs	<input type="checkbox"/>	 GENESIS™
	12'	143"	1 <input checked="" type="checkbox"/> <input type="checkbox"/> 346-144	29	181 lbs	<input type="checkbox"/>	
	13'	152.25"	1 <input checked="" type="checkbox"/> <input type="checkbox"/> 346-156	31	194 lbs	<input type="checkbox"/>	
	14'	171"	1 <input checked="" type="checkbox"/> <input type="checkbox"/> 346-168	35	206 lbs	<input type="checkbox"/>	
5' HEIGHT	15'	180.25"	1 <input checked="" type="checkbox"/> <input type="checkbox"/> 346-180	37	219 lbs	<input type="checkbox"/>	 WARRIOR™
	16'	189.75"	1 <input checked="" type="checkbox"/> <input type="checkbox"/> 346-192	39	232 lbs	<input type="checkbox"/>	
	3.5'	40"	1 <input checked="" type="checkbox"/> <input type="checkbox"/> 358-42	7	66 lbs	<input type="checkbox"/>	
	4'	49.5"	1 <input checked="" type="checkbox"/> <input type="checkbox"/> 358-48	9	77 lbs	<input type="checkbox"/>	
	5'	58.75"	1 <input checked="" type="checkbox"/> <input type="checkbox"/> 358-60	11	96 lbs	<input type="checkbox"/>	 GENESIS™
	6'	68"	1 <input checked="" type="checkbox"/> <input type="checkbox"/> 358-72	13	103 lbs	<input type="checkbox"/>	
	7'	86.75"	1 <input checked="" type="checkbox"/> <input type="checkbox"/> 358-84	17	118 lbs	<input type="checkbox"/>	
	8'	95.5"	1 <input checked="" type="checkbox"/> <input type="checkbox"/> 358-96	19	131 lbs	<input type="checkbox"/>	
	9'	105.5"	1 <input checked="" type="checkbox"/> <input type="checkbox"/> 358-108	21	159 lbs	<input type="checkbox"/>	 WARRIOR™
	10'	114.75"	1 <input checked="" type="checkbox"/> <input type="checkbox"/> 358-120	23	162 lbs	<input type="checkbox"/>	
	11'	133.5"	1 <input checked="" type="checkbox"/> <input type="checkbox"/> 358-132	27	185 lbs	<input type="checkbox"/>	
	12'	143"	1 <input checked="" type="checkbox"/> <input type="checkbox"/> 358-144	29	208 lbs	<input type="checkbox"/>	
13'	152.25"	1 <input checked="" type="checkbox"/> <input type="checkbox"/> 358-156	31	222 lbs	<input type="checkbox"/>	 WARRIOR™	
14'	171"	1 <input checked="" type="checkbox"/> <input type="checkbox"/> 358-168	35	235 lbs	<input type="checkbox"/>		
15'	180.25"	1 <input checked="" type="checkbox"/> <input type="checkbox"/> 358-180	37	249 lbs	<input type="checkbox"/>		
16'	189.75"	1 <input checked="" type="checkbox"/> <input type="checkbox"/> 358-192	39	262 lbs	<input type="checkbox"/>		

6', 7' & 8' HEIGHTS CONTINUED ON NEXT PAGES

= FENCE STYLES AVAILABLE | **C** = Classic **M** = Majestic **G** = Genesis **W** = Warrior

= COLOR OPTIONS AVAILABLE | **B** = Black **N** = Bronze **W** = White **S** = Sand

= NON-STOCKED PRODUCT

For details, see Ameristar's Sales Policy in the catalog guide.

Effective: 01/05/21

AEGIS PLUS® | 3-RAIL SWING GATES

4" AIR GAP | STANDARD BOTTOM | GATE HARDWARE SOLD SEPARATELY

	OPENING	LEAF WIDTH	ITEM NUMBER	PICKET QTY	WEIGHT	STOCKING
6' HEIGHT	3.5'	40"	1 <input checked="" type="checkbox"/> <input type="checkbox"/> 370-42	7	75 lbs	<input type="checkbox"/>
	4'	49.5"	1 <input checked="" type="checkbox"/> <input type="checkbox"/> 370-48	9	87 lbs	<input type="checkbox"/>
	5'	58.75"	1 <input checked="" type="checkbox"/> <input type="checkbox"/> 370-60	11	109 lbs	<input type="checkbox"/>
	6'	68"	1 <input checked="" type="checkbox"/> <input type="checkbox"/> 370-72	13	116 lbs	<input type="checkbox"/>
	7'	86.75"	1 <input checked="" type="checkbox"/> <input type="checkbox"/> 370-84	17	132 lbs	<input type="checkbox"/>
	8'	95.5"	1 <input checked="" type="checkbox"/> <input type="checkbox"/> 370-96	19	147 lbs	<input type="checkbox"/>
	9'	105.5"	1 <input checked="" type="checkbox"/> <input type="checkbox"/> 370-108	21	161 lbs	<input type="checkbox"/>
	10'	114.75"	1 <input checked="" type="checkbox"/> <input type="checkbox"/> 370-120	23	181 lbs	<input type="checkbox"/>
	11'	133.5"	1 <input checked="" type="checkbox"/> <input type="checkbox"/> 370-132	27	207 lbs	<input type="checkbox"/>
	12'	143"	1 <input checked="" type="checkbox"/> <input type="checkbox"/> 370-144	29	233 lbs	<input type="checkbox"/>
	13'	152.25"	1 <input checked="" type="checkbox"/> <input type="checkbox"/> 370-156	31	248 lbs	<input type="checkbox"/>
	14'	171"	1 <input checked="" type="checkbox"/> <input type="checkbox"/> 370-168	35	263 lbs	<input type="checkbox"/>
7' HEIGHT	15'	180.25"	1 <input checked="" type="checkbox"/> <input type="checkbox"/> 370-180	37	279 lbs	<input type="checkbox"/>
	16'	189.75"	1 <input checked="" type="checkbox"/> <input type="checkbox"/> 370-192	39	294 lbs	<input type="checkbox"/>
	3.5'	40"	1 <input checked="" type="checkbox"/> <input type="checkbox"/> 382-42	7	84 lbs	<input type="checkbox"/>
	4'	49.5"	1 <input checked="" type="checkbox"/> <input type="checkbox"/> 382-48	9	97 lbs	<input type="checkbox"/>
	5'	58.75"	1 <input checked="" type="checkbox"/> <input type="checkbox"/> 382-60	11	121 lbs	<input type="checkbox"/>
	6'	68"	1 <input checked="" type="checkbox"/> <input type="checkbox"/> 382-72	13	128 lbs	<input type="checkbox"/>
	7'	86.75"	1 <input checked="" type="checkbox"/> <input type="checkbox"/> 382-84	17	147 lbs	<input type="checkbox"/>
	8'	95.5"	1 <input checked="" type="checkbox"/> <input type="checkbox"/> 382-96	19	162 lbs	<input type="checkbox"/>
	9'	105.5"	1 <input checked="" type="checkbox"/> <input type="checkbox"/> 382-108	21	177 lbs	<input type="checkbox"/>
	10'	114.75"	1 <input checked="" type="checkbox"/> <input type="checkbox"/> 382-120	23	200 lbs	<input type="checkbox"/>
	11'	133.5"	1 <input checked="" type="checkbox"/> <input type="checkbox"/> 382-132	27	236 lbs	<input type="checkbox"/>
	12'	143"	1 <input checked="" type="checkbox"/> <input type="checkbox"/> 382-144	29	272 lbs	<input type="checkbox"/>
13'	152.25"	1 <input checked="" type="checkbox"/> <input type="checkbox"/> 382-156	31	282 lbs	<input type="checkbox"/>	
14'	171"	1 <input checked="" type="checkbox"/> <input type="checkbox"/> 382-168	35	292 lbs	<input type="checkbox"/>	
15'	180.25"	1 <input checked="" type="checkbox"/> <input type="checkbox"/> 382-180	37	309 lbs	<input type="checkbox"/>	
16'	189.75"	1 <input checked="" type="checkbox"/> <input type="checkbox"/> 382-192	39	325 lbs	<input type="checkbox"/>	

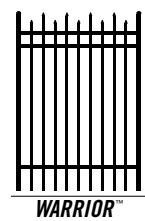
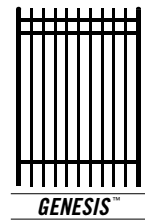
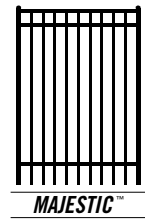
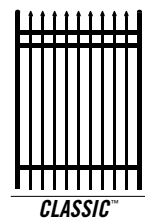

8' HEIGHTS CONTINUED ON NEXT PAGE

= FENCE STYLES AVAILABLE | **C** = Classic **M** = Majestic **G** = Genesis **W** = Warrior
 = COLOR OPTIONS AVAILABLE | **B** = Black **N** = Bronze **W** = White **S** = Sand
 = NON-STOCKED PRODUCT
 For details, see Ameristar's Sales Policy in the catalog guide.

Effective: 01/05/21

AMERISTAR

ASSA ABLOY

TO PLACE YOUR ORDER CALL 888-333-3422 | VISIT AMERISTARFENCE.COM

AEGIS PLUS® | 3-RAIL SWING GATES

4" AIR GAP | STANDARD BOTTOM | GATE HARDWARE SOLD SEPARATELY

OPENING	LEAF WIDTH	ITEM NUMBER	PICKET QTY	WEIGHT	STOCKING
3.5'	40"	1☒⊗394-42	7	93 lbs	⊙
4'	49.5"	1☒⊗394-48	9	107 lbs	⊙
5'	58.75"	1☒⊗394-60	11	134 lbs	⊙
6'	68"	1☒⊗394-72	13	141 lbs	⊙
7'	86.75"	1☒⊗394-84	17	161 lbs	⊙
8'	95.5"	1☒⊗394-96	19	178 lbs	⊙
9'	105.5"	1☒⊗394-108	21	193 lbs	⊙
10'	114.75"	1☒⊗394-120	23	220 lbs	⊙
11'	133.5"	1☒⊗394-132	27	266 lbs	⊙
12'	143"	1☒⊗394-144	29	288 lbs	⊙
13'	152.25"	1☒⊗394-156	31	302 lbs	⊙
14'	171"	1☒⊗394-168	35	320 lbs	⊙
15'	180.25"	1☒⊗394-180	37	338 lbs	⊙
16'	189.75"	1☒⊗394-192	39	356 lbs	⊙

8'
HEIGHT

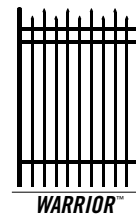
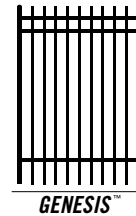
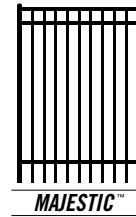
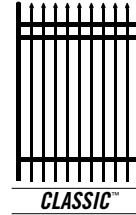

☒ = FENCE STYLES AVAILABLE | **C** = Classic **M** = Majestic **G** = Genesis **W** = Warrior

⊗ = COLOR OPTIONS AVAILABLE | **B** = Black **N** = Bronze **W** = White **S** = Sand













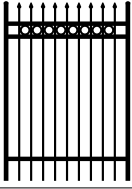





























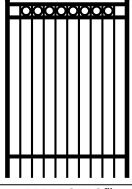











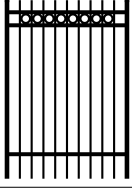



























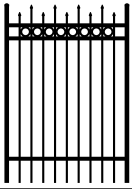

⊙ = NON-STOCKED PRODUCT

For details, see Ameristar's Sales Policy in the catalog guide.

Effective: 01/05/21

AEGIS PLUS® | 3-RAIL SWING GATES WITH RINGS

4" AIR GAP | STANDARD BOTTOM | GATE HARDWARE SOLD SEPARATELY

	OPENING	LEAF WIDTH	ITEM NUMBER	PICKET QTY	WEIGHT	STOCKING		
3' HEIGHT	3.5'	40"	1   334-42R	7	52 lbs		 CLASSIC™	
	4'	49.5"	1   334-48R	9	63 lbs			
	5'	58.75"	1   334-60R	11	79 lbs			
	6'	68"	1   334-72R	13	88 lbs			
	7'	86.75"	1   334-84R	17	99 lbs			
	8'	95.5"	1   334-96R	19	114 lbs			
	9'	105.5"	1   334-108R	21	129 lbs			
	10'	114.75"	1   334-120R	23	140 lbs			
	11'	133.5"	1   334-132R	27	157 lbs			
	12'	143"	1   334-144R	29	174 lbs			
3.5' HEIGHT	13'	152.25"	1   334-156R	31	187 lbs		 MAJESTIC™	
	14'	171"	1   334-168R	35	201 lbs			
	15'	180.25"	1   334-180R	37	214 lbs			
	16'	189.75"	1   334-192R	39	229 lbs			
	3.5'	40"	1   340-42R	7	57 lbs			 GENESIS™
	4'	49.5"	1   340-48R	9	68 lbs			
	5'	58.75"	1   340-60R	11	85 lbs			
	6'	68"	1   340-72R	13	94 lbs			
	7'	86.75"	1   340-84R	17	107 lbs			
	8'	95.5"	1   340-96R	19	122 lbs			
9'	105.5"	1   340-108R	21	137 lbs				
10'	114.75"	1   340-120R	23	150 lbs				
11'	133.5"	1   340-132R	27	169 lbs				
12'	143"	1   340-144R	29	188 lbs				
3.5' HEIGHT	13'	152.25"	1   340-156R	31	201 lbs		 WARRIOR™	
	14'	171"	1   340-168R	35	216 lbs			
	15'	180.25"	1   340-180R	37	229 lbs			
	16'	189.75"	1   340-192R	39	244 lbs			

4', 5', 6', 7' & 8' HEIGHTS CONTINUED ON NEXT PAGES

 = FENCE STYLES AVAILABLE | **C** = Classic **M** = Majestic **G** = Genesis **W** = Warrior

 = COLOR OPTIONS AVAILABLE | **B** = Black **N** = Bronze **W** = White **S** = Sand

 = NON-STOCKED PRODUCT

For details, see Ameristar's Sales Policy in the catalog guide.

Effective: 01/05/21

AMERISTAR

ASSA ABLOY

TO PLACE YOUR ORDER CALL 888-333-3422 | VISIT AMERISTARFENCE.COM

AEGIS PLUS® | 3-RAIL SWING GATES WITH RINGS

4" AIR GAP | STANDARD BOTTOM | GATE HARDWARE SOLD SEPARATELY

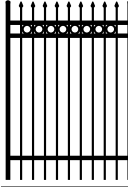
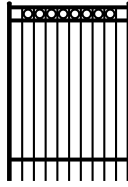
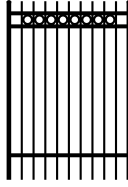
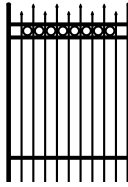
	OPENING	LEAF WIDTH	ITEM NUMBER	PICKET QTY	WEIGHT	STOCKING		
4' HEIGHT	3.5'	40"	1 <input checked="" type="checkbox"/> <input type="checkbox"/> 346-42R	7	61 lbs	<input type="checkbox"/>	 CLASSIC™	
	4'	49.5"	1 <input checked="" type="checkbox"/> <input type="checkbox"/> 346-48R	9	73 lbs	<input type="checkbox"/>		
	5'	58.75"	1 <input checked="" type="checkbox"/> <input type="checkbox"/> 346-60R	11	91 lbs	<input type="checkbox"/>		
		6'	68"	1 <input checked="" type="checkbox"/> <input type="checkbox"/> 346-72R	13	100 lbs	<input type="checkbox"/>	 MAJESTIC™
		7'	86.75"	1 <input checked="" type="checkbox"/> <input type="checkbox"/> 346-84R	17	114 lbs	<input type="checkbox"/>	
		8'	95.5"	1 <input checked="" type="checkbox"/> <input type="checkbox"/> 346-96R	19	129 lbs	<input type="checkbox"/>	
		9'	105.5"	1 <input checked="" type="checkbox"/> <input type="checkbox"/> 346-108R	21	144 lbs	<input type="checkbox"/>	
		10'	114.75"	1 <input checked="" type="checkbox"/> <input type="checkbox"/> 346-120R	23	159 lbs	<input type="checkbox"/>	
		11'	133.5"	1 <input checked="" type="checkbox"/> <input type="checkbox"/> 346-132R	27	180 lbs	<input type="checkbox"/>	
		12'	143"	1 <input checked="" type="checkbox"/> <input type="checkbox"/> 346-144R	29	201 lbs	<input type="checkbox"/>	 GENESIS™
		13'	152.25"	1 <input checked="" type="checkbox"/> <input type="checkbox"/> 346-156R	31	215 lbs	<input type="checkbox"/>	
		14'	171"	1 <input checked="" type="checkbox"/> <input type="checkbox"/> 346-168R	35	230 lbs	<input type="checkbox"/>	
	15'	180.25"	1 <input checked="" type="checkbox"/> <input type="checkbox"/> 346-180R	37	244 lbs	<input type="checkbox"/>		
5' HEIGHT	16'	189.75"	1 <input checked="" type="checkbox"/> <input type="checkbox"/> 346-192R	39	259 lbs	<input type="checkbox"/>	 WARRIOR™	
	3.5'	40"	1 <input checked="" type="checkbox"/> <input type="checkbox"/> 358-42R	7	68 lbs	<input type="checkbox"/>		
		4'	49.5"	1 <input checked="" type="checkbox"/> <input type="checkbox"/> 358-48R	9	78 lbs	<input type="checkbox"/>	
		5'	58.75"	1 <input checked="" type="checkbox"/> <input type="checkbox"/> 358-60R	11	98 lbs	<input type="checkbox"/>	
		6'	68"	1 <input checked="" type="checkbox"/> <input type="checkbox"/> 358-72R	13	103 lbs	<input type="checkbox"/>	
		7'	86.75"	1 <input checked="" type="checkbox"/> <input type="checkbox"/> 358-84R	17	117 lbs	<input type="checkbox"/>	
		8'	95.5"	1 <input checked="" type="checkbox"/> <input type="checkbox"/> 358-96R	19	129 lbs	<input type="checkbox"/>	
		9'	105.5"	1 <input checked="" type="checkbox"/> <input type="checkbox"/> 358-108R	21	144 lbs	<input type="checkbox"/>	
		10'	114.75"	1 <input checked="" type="checkbox"/> <input type="checkbox"/> 358-120R	23	159 lbs	<input type="checkbox"/>	
		11'	133.5"	1 <input checked="" type="checkbox"/> <input type="checkbox"/> 358-132R	27	183 lbs	<input type="checkbox"/>	
	12'	143"	1 <input checked="" type="checkbox"/> <input type="checkbox"/> 358-144R	29	206 lbs	<input type="checkbox"/>		
	13'	152.25"	1 <input checked="" type="checkbox"/> <input type="checkbox"/> 358-156R	31	220 lbs	<input type="checkbox"/>		
	14'	171"	1 <input checked="" type="checkbox"/> <input type="checkbox"/> 358-168R	35	233 lbs	<input type="checkbox"/>		
	15'	180.25"	1 <input checked="" type="checkbox"/> <input type="checkbox"/> 358-180R	37	246 lbs	<input type="checkbox"/>		
	16'	189.75"	1 <input checked="" type="checkbox"/> <input type="checkbox"/> 358-192R	39	258 lbs	<input type="checkbox"/>		

6', 7' & 8' HEIGHTS CONTINUED ON NEXT PAGES

= FENCE STYLES AVAILABLE | **C** = Classic **M** = Majestic **G** = Genesis **W** = Warrior

= COLOR OPTIONS AVAILABLE | **B** = Black **N** = Bronze **W** = White **S** = Sand

= NON-STOCKED PRODUCT

For details, see Ameristar's Sales Policy in the catalog guide.

Effective: 01/05/21

AEGIS PLUS® | 3-RAIL SWING GATES WITH RINGS

4" AIR GAP | STANDARD BOTTOM | GATE HARDWARE SOLD SEPARATELY

	OPENING	LEAF WIDTH	ITEM NUMBER	PICKET QTY	WEIGHT	STOCKING
6' HEIGHT	3.5'	40"	1☒☉370-42R	7	79 lbs	☉
	4'	49.5"	1☒☉370-48R	9	93 lbs	☉
	5'	58.75"	1☒☉370-60R	11	116 lbs	☉
	6'	68"	1☒☉370-72R	13	125 lbs	☉
	7'	86.75"	1☒☉370-84R	17	143 lbs	☉
	8'	95.5"	1☒☉370-96R	19	160 lbs	☉
	9'	105.5"	1☒☉370-108R	21	175 lbs	☉
	10'	114.75"	1☒☉370-120R	23	197 lbs	☉
	11'	133.5"	1☒☉370-132R	27	225 lbs	☉
	12'	143"	1☒☉370-144R	29	253 lbs	☉
	13'	152.25"	1☒☉370-156R	31	269 lbs	☉
	14'	171"	1☒☉370-168R	35	287 lbs	☉
	15'	180.25"	1☒☉370-180R	37	304 lbs	☉
7' HEIGHT	16'	189.75"	1☒☉370-192R	39	321 lbs	☉
	3.5'	40"	1☒☉382-42R	7	88 lbs	☉
	4'	49.5"	1☒☉382-48R	9	103 lbs	☉
	5'	58.75"	1☒☉382-60R	11	128 lbs	☉
	6'	68"	1☒☉382-72R	13	137 lbs	☉
	7'	86.75"	1☒☉382-84R	17	158 lbs	☉
	8'	95.5"	1☒☉382-96R	19	175 lbs	☉
	9'	105.5"	1☒☉382-108R	21	191 lbs	☉
	10'	114.75"	1☒☉382-120R	23	216 lbs	☉
	11'	133.5"	1☒☉382-132R	27	254 lbs	☉
	12'	143"	1☒☉382-144R	29	292 lbs	☉
	13'	152.25"	1☒☉382-156R	31	303 lbs	☉
	14'	171"	1☒☉382-168R	35	316 lbs	☉
15'	180.25"	1☒☉382-180R	37	334 lbs	☉	
16'	189.75"	1☒☉382-192R	39	352 lbs	☉	

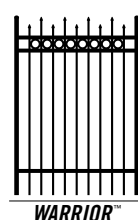
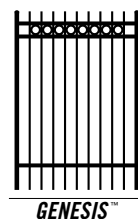
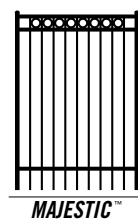
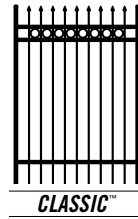

8' HEIGHTS CONTINUED ON NEXT PAGE

☒ = FENCE STYLES AVAILABLE | C = Classic M = Majestic G = Genesis W = Warrior
 ☉ = COLOR OPTIONS AVAILABLE | B = Black N = Bronze W = White S = Sand
 ☉ = NON-STOCKED PRODUCT
 For details, see Ameristar's Sales Policy in the catalog guide.

Effective: 01/05/21

AMERISTAR

ASSA ABLOY

TO PLACE YOUR ORDER CALL 888-333-3422 | VISIT AMERISTARFENCE.COM

AEGIS PLUS® | 3-RAIL SWING GATES WITH RINGS

4" AIR GAP | STANDARD BOTTOM | GATE HARDWARE SOLD SEPARATELY

OPENING	LEAF WIDTH	ITEM NUMBER	PICKET QTY	WEIGHT	STOCKING
3.5'	40"	1☒⊗394-42R	7	97 lbs	⊙
4'	49.5"	1☒⊗394-48R	9	113 lbs	⊙
5'	58.75"	1☒⊗394-60R	11	141 lbs	⊙
6'	68"	1☒⊗394-72R	13	150 lbs	⊙
7'	86.75"	1☒⊗394-84R	17	172 lbs	⊙
8'	95.5"	1☒⊗394-96R	19	191 lbs	⊙
9'	105.5"	1☒⊗394-108R	21	207 lbs	⊙
10'	114.75"	1☒⊗394-120R	23	236 lbs	⊙
11'	133.5"	1☒⊗394-132R	27	284 lbs	⊙
12'	143"	1☒⊗394-144R	29	331 lbs	⊙
13'	152.25"	1☒⊗394-156R	31	337 lbs	⊙
14'	171"	1☒⊗394-168R	35	344 lbs	⊙
15'	180.25"	1☒⊗394-180R	37	363 lbs	⊙
16'	189.75"	1☒⊗394-192R	39	383 lbs	⊙

8'
HEIGHT

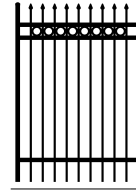

CLASSIC™

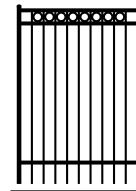

MAJESTIC™



GENESIS™

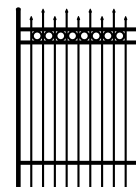

WARRIOR™

☒ = FENCE STYLES AVAILABLE | **C** = Classic **M** = Majestic **G** = Genesis **W** = Warrior

⊗ = COLOR OPTIONS AVAILABLE | **B** = Black **N** = Bronze **W** = White **S** = Sand

⊙ = NON-STOCKED PRODUCT

For details, see Ameristar's Sales Policy in the catalog guide.

Effective: 01/05/21

Effective: 01/05/21

AMERISTAR

ASSA ABLOY

| *TO PLACE YOUR ORDER CALL 888-333-3422* | *VISIT AMERISTARFENCE.COM*

AEGIS PLUS® | SINGLE SWING ARCHED GATE SPECIFICATIONS

2"sq x .25" wall GATE ENDS | 1" x 2" x .25" wall RAILS | .75" x .125" wall PICKETS | ALUMINUM ARCHED GATES

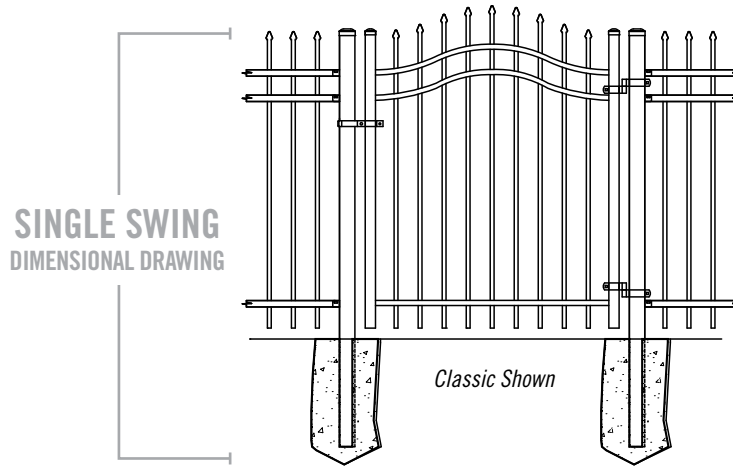

EGBSX25 / EGBSX3
FORK LATCH/BOX
HINGE KITS

EGBSXA
AMERISTAR LOCK/BOX
HINGE KIT

OPENING	LEAF WIDTH*	HC	LC	P _S	HC	LC	P _S
3.5'	40"	2.375"	2"	44.375"	2.375"	.625"	43"
4'	49.5"	2.375"	2"	53.875"	2.375"	.625"	52.5"
5'	58.75"	2.375"	2"	63.125"	2.375"	.625"	61.75"
6'	68"	2.375"	2"	72.375"	2.375"	.625"	71"
7'	86.75"	2.375"	2"	91.125"	2.375"	.625"	89.75"

W = width* | HC = hinge clearance | LC = latch clearance | P_S = gate post spacing**
 * From outside to outside | ** From inside to inside

SINGLE SWING
 ARCHED
 HARDWARE KITS &
 POST INTERSPACES

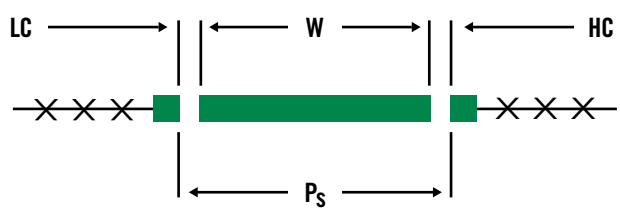

Effective: 01/05/21

AEGIS PLUS® | 2-RAIL ARCHED SWING GATES

4" AIR GAP | STANDARD BOTTOM | GATE HARDWARE SOLD SEPARATELY

	OPENING	LEAF WIDTH	ITEM NUMBER	PICKET QTY	WEIGHT	STOCKING
3' HEIGHT	3.5'	40"	1 <input checked="" type="checkbox"/> <input checked="" type="checkbox"/> 234-42A	7	32 lbs	<input checked="" type="checkbox"/>
	4'	49.5"	1 <input checked="" type="checkbox"/> <input checked="" type="checkbox"/> 234-48A	9	35 lbs	<input checked="" type="checkbox"/>
	5'	58.75"	1 <input checked="" type="checkbox"/> <input checked="" type="checkbox"/> 234-60A	11	40 lbs	<input checked="" type="checkbox"/>
	6'	68"	1 <input checked="" type="checkbox"/> <input checked="" type="checkbox"/> 234-72A	13	46 lbs	<input checked="" type="checkbox"/>
	7'	86.75"	1 <input checked="" type="checkbox"/> <input checked="" type="checkbox"/> 234-84A	17	55 lbs	<input checked="" type="checkbox"/>
3.5' HEIGHT	3.5'	40"	1 <input checked="" type="checkbox"/> <input checked="" type="checkbox"/> 240-42A	7	36 lbs	<input checked="" type="checkbox"/>
	4'	49.5"	1 <input checked="" type="checkbox"/> <input checked="" type="checkbox"/> 240-48A	9	40 lbs	<input checked="" type="checkbox"/>
	5'	58.75"	1 <input checked="" type="checkbox"/> <input checked="" type="checkbox"/> 240-60A	11	45 lbs	<input checked="" type="checkbox"/>
	6'	68"	1 <input checked="" type="checkbox"/> <input checked="" type="checkbox"/> 240-72A	13	51 lbs	<input checked="" type="checkbox"/>
	7'	86.75"	1 <input checked="" type="checkbox"/> <input checked="" type="checkbox"/> 240-84A	17	62 lbs	<input checked="" type="checkbox"/>
4' HEIGHT	3.5'	40"	1 <input checked="" type="checkbox"/> <input checked="" type="checkbox"/> 246-42A	7	39 lbs	<input checked="" type="checkbox"/>
	4'	49.5"	1 <input checked="" type="checkbox"/> <input checked="" type="checkbox"/> 246-48A	9	44 lbs	<input checked="" type="checkbox"/>
	5'	58.75"	1 <input checked="" type="checkbox"/> <input checked="" type="checkbox"/> 246-60A	11	50 lbs	<input checked="" type="checkbox"/>
	6'	68"	1 <input checked="" type="checkbox"/> <input checked="" type="checkbox"/> 246-72A	13	56 lbs	<input checked="" type="checkbox"/>
	7'	86.75"	1 <input checked="" type="checkbox"/> <input checked="" type="checkbox"/> 246-84A	17	68 lbs	<input checked="" type="checkbox"/>
5' HEIGHT	3.5'	40"	1 <input checked="" type="checkbox"/> <input checked="" type="checkbox"/> 258-42A	7	46 lbs	<input checked="" type="checkbox"/>
	4'	49.5"	1 <input checked="" type="checkbox"/> <input checked="" type="checkbox"/> 258-48A	9	53 lbs	<input checked="" type="checkbox"/>
	5'	58.75"	1 <input checked="" type="checkbox"/> <input checked="" type="checkbox"/> 258-60A	11	60 lbs	<input checked="" type="checkbox"/>
	6'	68"	1 <input checked="" type="checkbox"/> <input checked="" type="checkbox"/> 258-72A	13	66 lbs	<input checked="" type="checkbox"/>
	7'	86.75"	1 <input checked="" type="checkbox"/> <input checked="" type="checkbox"/> 258-84A	17	81 lbs	<input checked="" type="checkbox"/>
6' HEIGHT	3.5'	40"	1 <input checked="" type="checkbox"/> <input checked="" type="checkbox"/> 270-42A	7	54 lbs	<input checked="" type="checkbox"/>
	4'	49.5"	1 <input checked="" type="checkbox"/> <input checked="" type="checkbox"/> 270-48A	9	62 lbs	<input checked="" type="checkbox"/>
	5'	58.75"	1 <input checked="" type="checkbox"/> <input checked="" type="checkbox"/> 270-60A	11	69 lbs	<input checked="" type="checkbox"/>
	6'	68"	1 <input checked="" type="checkbox"/> <input checked="" type="checkbox"/> 270-72A	13	77 lbs	<input checked="" type="checkbox"/>
	7'	86.75"	1 <input checked="" type="checkbox"/> <input checked="" type="checkbox"/> 270-84A	17	94 lbs	<input checked="" type="checkbox"/>

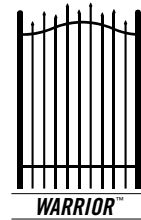
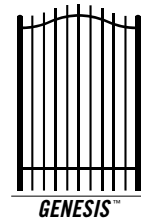
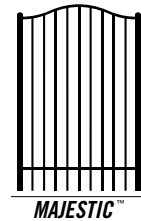
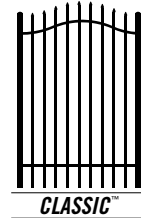

= FENCE STYLES AVAILABLE | **C** = Classic **M** = Majestic **G** = Genesis **W** = Warrior

= COLOR OPTIONS AVAILABLE | **B** = Black **N** = Bronze **W** = White **S** = Sand

= NON-STOCKED PRODUCT

For details, see Ameristar's Sales Policy in the catalog guide.

Effective: 01/05/21

AMERISTAR

ASSA ABLOY

TO PLACE YOUR ORDER CALL 888-333-3422 | VISIT AMERISTARFENCE.COM

AEGIS PLUS® | 3-RAIL ARCHED SWING GATES

4" AIR GAP | STANDARD BOTTOM | GATE HARDWARE SOLD SEPARATELY

	OPENING	LEAF WIDTH	ITEM NUMBER	PICKET QTY	WEIGHT	STOCKING
3' HEIGHT	3.5'	40"	1 ☒ ⊗ 334-42A	7	35 lbs	☉
	4'	49.5"	1 ☒ ⊗ 334-48A	9	39 lbs	☉
	5'	58.75"	1 ☒ ⊗ 334-60A	11	45 lbs	☉
	6'	68"	1 ☒ ⊗ 334-72A	13	52 lbs	☉
	7'	86.75"	1 ☒ ⊗ 334-84A	17	62 lbs	☉
3.5' HEIGHT	3.5'	40"	1 ☒ ⊗ 340-42A	7	39 lbs	☉
	4'	49.5"	1 ☒ ⊗ 340-48A	9	44 lbs	☉
	5'	58.75"	1 ☒ ⊗ 340-60A	11	50 lbs	☉
	6'	68"	1 ☒ ⊗ 340-72A	13	57 lbs	☉
	7'	86.75"	1 ☒ ⊗ 340-84A	17	69 lbs	☉
4' HEIGHT	3.5'	40"	1 ☒ ⊗ 346-42A	7	42 lbs	☉
	4'	49.5"	1 ☒ ⊗ 346-48A	9	48 lbs	☉
	5'	58.75"	1 ☒ ⊗ 346-60A	11	55 lbs	☉
	6'	68"	1 ☒ ⊗ 346-72A	13	62 lbs	☉
	7'	86.75"	1 ☒ ⊗ 346-84A	17	75 lbs	☉
5' HEIGHT	3.5'	40"	1 ☒ ⊗ 358-42A	7	49 lbs	☉
	4'	49.5"	1 ☒ ⊗ 358-48A	9	57 lbs	☉
	5'	58.75"	1 ☒ ⊗ 358-60A	11	65 lbs	☉
	6'	68"	1 ☒ ⊗ 358-72A	13	72 lbs	☉
	7'	86.75"	1 ☒ ⊗ 358-84A	17	88 lbs	☉
6' HEIGHT	3.5'	40"	1 ☒ ⊗ 370-42A	7	57 lbs	☉
	4'	49.5"	1 ☒ ⊗ 370-48A	9	66 lbs	☉
	5'	58.75"	1 ☒ ⊗ 370-60A	11	74 lbs	☉
	6'	68"	1 ☒ ⊗ 370-72A	13	83 lbs	☉
	7'	86.75"	1 ☒ ⊗ 370-84A	17	101 lbs	☉
7' HEIGHT	3.5'	40"	1 ☒ ⊗ 382-42A	7	73 lbs	☉
	4'	49.5"	1 ☒ ⊗ 382-48A	9	78 lbs	☉
	5'	58.75"	1 ☒ ⊗ 382-60A	11	89 lbs	☉
	6'	68"	1 ☒ ⊗ 382-72A	13	108 lbs	☉
	7'	86.75"	1 ☒ ⊗ 382-84A	17	124 lbs	☉
8' HEIGHT	3.5'	40"	1 ☒ ⊗ 394-42A	7	84 lbs	☉
	4'	49.5"	1 ☒ ⊗ 394-48A	9	89 lbs	☉
	5'	58.75"	1 ☒ ⊗ 394-60A	11	100 lbs	☉
	6'	68"	1 ☒ ⊗ 394-72A	13	120 lbs	☉
	7'	86.75"	1 ☒ ⊗ 394-84A	17	137 lbs	☉

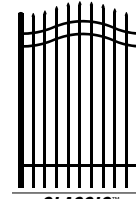

CLASSIC™

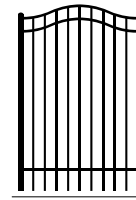

MAJESTIC™

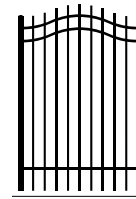

GENESIS™

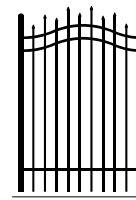

WARRIOR™

Effective: 01/05/21

AEGIS PLUS® | 3-RAIL ARCHED SWING GATES WITH RINGS

4" AIR GAP | STANDARD BOTTOM | GATE HARDWARE SOLD SEPARATELY

	OPENING	LEAF WIDTH	ITEM NUMBER	PICKET QTY	WEIGHT	STOCKING
3' HEIGHT	3.5'	40"	1 <input checked="" type="checkbox"/> <input checked="" type="checkbox"/> 334-42AR	7	34 lbs	⊙
	4'	49.5"	1 <input checked="" type="checkbox"/> <input checked="" type="checkbox"/> 334-48AR	9	41 lbs	⊙
	5'	58.75"	1 <input checked="" type="checkbox"/> <input checked="" type="checkbox"/> 334-60AR	11	54 lbs	⊙
	6'	68"	1 <input checked="" type="checkbox"/> <input checked="" type="checkbox"/> 334-72AR	13	71 lbs	⊙
	7'	86.75"	1 <input checked="" type="checkbox"/> <input checked="" type="checkbox"/> 334-84AR	17	86 lbs	⊙
3.5' HEIGHT	3.5'	40"	1 <input checked="" type="checkbox"/> <input checked="" type="checkbox"/> 340-42AR	7	40 lbs	⊙
	4'	49.5"	1 <input checked="" type="checkbox"/> <input checked="" type="checkbox"/> 340-48AR	9	47 lbs	⊙
	5'	58.75"	1 <input checked="" type="checkbox"/> <input checked="" type="checkbox"/> 340-60AR	11	60 lbs	⊙
	6'	68"	1 <input checked="" type="checkbox"/> <input checked="" type="checkbox"/> 340-72AR	13	77 lbs	⊙
	7'	86.75"	1 <input checked="" type="checkbox"/> <input checked="" type="checkbox"/> 340-84AR	17	93 lbs	⊙
4' HEIGHT	3.5'	40"	1 <input checked="" type="checkbox"/> <input checked="" type="checkbox"/> 346-42AR	7	45 lbs	⊙
	4'	49.5"	1 <input checked="" type="checkbox"/> <input checked="" type="checkbox"/> 346-48AR	9	52 lbs	⊙
	5'	58.75"	1 <input checked="" type="checkbox"/> <input checked="" type="checkbox"/> 346-60AR	11	65 lbs	⊙
	6'	68"	1 <input checked="" type="checkbox"/> <input checked="" type="checkbox"/> 346-72AR	13	83 lbs	⊙
	7'	86.75"	1 <input checked="" type="checkbox"/> <input checked="" type="checkbox"/> 346-84AR	17	99 lbs	⊙
5' HEIGHT	3.5'	40"	1 <input checked="" type="checkbox"/> <input checked="" type="checkbox"/> 358-42AR	7	56 lbs	⊙
	4'	49.5"	1 <input checked="" type="checkbox"/> <input checked="" type="checkbox"/> 358-48AR	9	63 lbs	⊙
	5'	58.75"	1 <input checked="" type="checkbox"/> <input checked="" type="checkbox"/> 358-60AR	11	76 lbs	⊙
	6'	68"	1 <input checked="" type="checkbox"/> <input checked="" type="checkbox"/> 358-72AR	13	95 lbs	⊙
	7'	86.75"	1 <input checked="" type="checkbox"/> <input checked="" type="checkbox"/> 358-84AR	17	112 lbs	⊙
6' HEIGHT	3.5'	40"	1 <input checked="" type="checkbox"/> <input checked="" type="checkbox"/> 370-42AR	7	67 lbs	⊙
	4'	49.5"	1 <input checked="" type="checkbox"/> <input checked="" type="checkbox"/> 370-48AR	9	74 lbs	⊙
	5'	58.75"	1 <input checked="" type="checkbox"/> <input checked="" type="checkbox"/> 370-60AR	11	87 lbs	⊙
	6'	68"	1 <input checked="" type="checkbox"/> <input checked="" type="checkbox"/> 370-72AR	13	107 lbs	⊙
	7'	86.75"	1 <input checked="" type="checkbox"/> <input checked="" type="checkbox"/> 370-84AR	17	125 lbs	⊙
7' HEIGHT	3.5'	40"	1 <input checked="" type="checkbox"/> <input checked="" type="checkbox"/> 382-42AR	7	78 lbs	⊙
	4'	49.5"	1 <input checked="" type="checkbox"/> <input checked="" type="checkbox"/> 382-48AR	9	85 lbs	⊙
	5'	58.75"	1 <input checked="" type="checkbox"/> <input checked="" type="checkbox"/> 382-60AR	11	98 lbs	⊙
	6'	68"	1 <input checked="" type="checkbox"/> <input checked="" type="checkbox"/> 382-72AR	13	118 lbs	⊙
	7'	86.75"	1 <input checked="" type="checkbox"/> <input checked="" type="checkbox"/> 382-84AR	17	138 lbs	⊙

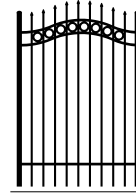

CLASSIC™

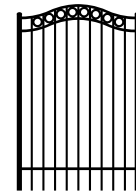

MAJESTIC™

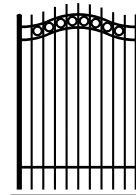

GENESIS™

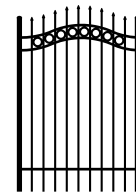

WARRIOR™

8' HEIGHTS CONTINUED ON NEXT PAGE

= FENCE STYLES AVAILABLE | **C** = Classic **M** = Majestic **G** = Genesis **W** = Warrior

= COLOR OPTIONS AVAILABLE | **B** = Black **N** = Bronze **W** = White **S** = Sand

⊙ = NON-STOCKED PRODUCT

For details, see Ameristar's Sales Policy in the catalog guide.

Effective: 01/05/21

AMERISTAR

ASSA ABLOY

TO PLACE YOUR ORDER CALL 888-333-3422 | VISIT AMERISTARFENCE.COM

AEGIS PLUS® | 3-RAIL ARCHED SWING GATES WITH RINGS

4" AIR GAP | STANDARD BOTTOM | GATE HARDWARE SOLD SEPARATELY

	OPENING	LEAF WIDTH	ITEM NUMBER	PICKET QTY	WEIGHT	STOCKING
8' HEIGHT	3.5'	40"	1☒☉394-42AR	7	89 lbs	☉
	4'	49.5"	1☒☉394-48AR	9	96 lbs	☉
	5'	58.75"	1☒☉394-60AR	11	109 lbs	☉
	6'	68"	1☒☉394-72AR	13	131 lbs	☉
	7'	86.75"	1☒☉394-84AR	17	151 lbs	☉

☒ = FENCE STYLES AVAILABLE | **C** = Classic | **M** = Majestic | **G** = Genesis | **W** = Warrior

☉ = COLOR OPTIONS AVAILABLE | **B** = Black | **N** = Bronze | **W** = White | **S** = Sand

☉ = NON-STOCKED PRODUCT

For details, see Ameristar's Sales Policy in the catalog guide.

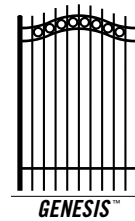
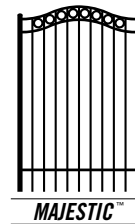
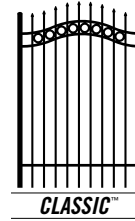

Effective: 01/05/21

Effective: 01/05/21

AMERISTAR

ASSA ABLOY

| *TO PLACE YOUR ORDER CALL 888-333-3422* | *VISIT AMERISTARFENCE.COM*

Effective: 01/05/21

Effective: 01/05/21

AMERISTAR

ASSA ABLOY

| *TO PLACE YOUR ORDER CALL 888-333-3422* | *VISIT AMERISTARFENCE.COM*