

Echelon®



RESIDENTIAL ORNAMENTAL ALUMINUM FENCE

Echelon residential aluminum fence not only *provides safety and security*, but also adds both *value and beauty to your investment*. With Echelons' additional strength from the internally reinforced rail, high quality powder coated finish, and fully welded gates, you can be assured *years of maintenance-free value*.



PRIMARY APPLICATIONS

- ▶ ***Single Family Residence***
- ▶ ***Gated Subdivision***
- ▶ ***Golf Courses***
- ▶ ***Decorative Accent***



FENCE PRODUCTS

AMERISTARFENCE.COM | 888-333-3422

Experience a safer and more open world

AMERISTAR®

ASSA ABLOY

Echelon®

RESIDENTIAL ORNAMENTAL ALUMINIUM FENCE

.590"sq x .050" wall PICKETS | 1" x 1.125" (.072" side / .055" top) ForeRunner™ RAILS | 2"sq x .060" wall POSTS

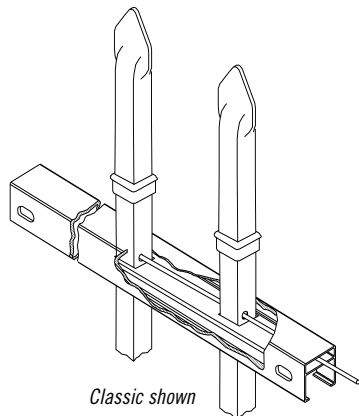

STYLE OPTIONS

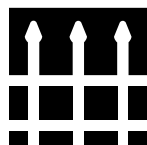

CLASSIC™

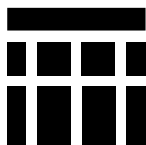

MAJESTIC™

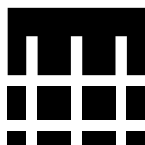

GENESIS™

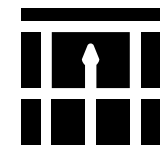

CONQUORER™



FABRICATION & DESIGN

Ameristar crafted the ForeRunner rail to increase strength through architecture. The innovative design of the ForeRunner rail contains an internally secured rod that allows for variable pitch connection, high angle biasability and is easy to install. Internal security eliminates the need for visually unappealing external fasteners.



POWDERED COATED SUPERIOR FINISH

Echelon features a state of the art polyester powder coating system that provides a super durable and scratch resistant finish. This eco-friendly process provides years of long-lasting durability and maintenance-free ownership.



LIFETIME LIMITED WARRANTY

The Echelon families of aluminum fencing products are manufactured from superior quality materials by skilled craftsmen with the highest standards of workmanship in the industry. Ameristar is confident in offering Echelon with a limited lifetime warranty, backed by over 30 years of demonstrated excellence in manufacturing of ornamental fence.



DOMESTIC MANUFACTURING

Ameristar is committed to providing products that are manufactured in the USA. We have made significant investments in technology, process improvement, and employee training in an effort to secure American jobs and combat inferior import products.



FENCE PRODUCTS

TO PLACE YOUR ORDER CALL 888-333-3422

VISIT AMERISTARFENCE.COM

ECHELON® | 2 & 3-RAIL OPTIONS | 4" AIR-SPACE

STANDARD BOTTOM & FLUSH BOTTOM OPTIONS AVAILABLE

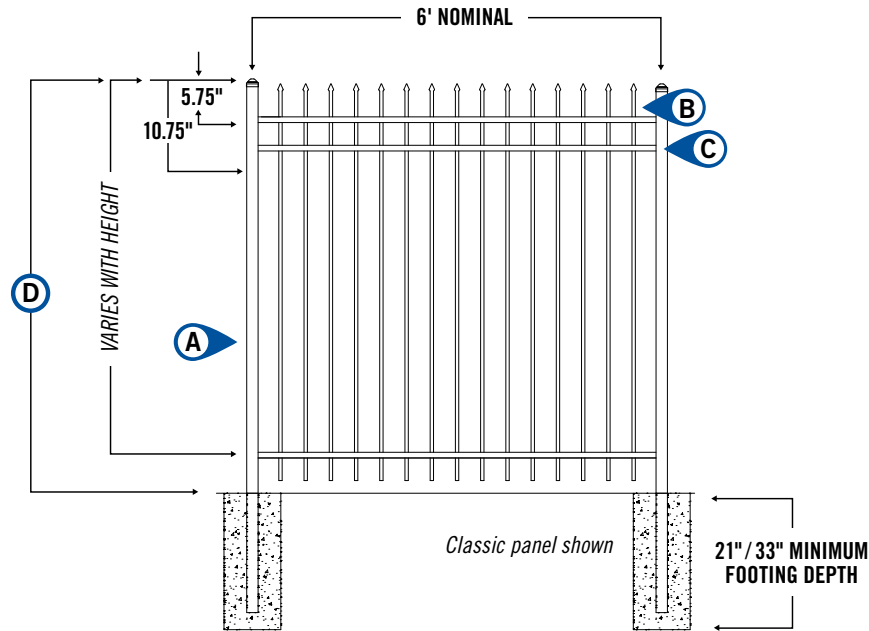

- Ⓐ 2"sq x .060" wall POSTS
- Ⓑ 0.590"sq x .050" wall PICKETS
- Ⓒ 1.125"w x 1"h (0.072" side / 0.055" top) ForeRunner™ RAILS
- Ⓓ 4', 4½', 5' & 6' PANEL HEIGHTS

Refer to construction specification & tables within this section for recommended post space by bracket type

Effective: 01/05/21

ECHELON® | 3-RAIL PANELS | 4" AIR SPACE

STANDARD BOTTOM | 6' PANEL LENGTH (71.5" actual width) | 15 PICKETS PER PANEL | 24 PANELS PER PALLET

PANEL	ITEM NUMBER	WEIGHT	STOCKING
4'	A0☒☉ 3466	13 lbs	CB MB GB
5'	A0☒☉ 3586	15 lbs	CB MB GB
6'	A0☒☉ 3706	17 lbs	CB MB GB

☒ = FENCE STYLES AVAILABLE | **C** = Classic | **M** = Majestic | **G** = Genesis | **R** = Conqueror

☉ = COLOR OPTIONS AVAILABLE | **B** = Black | **N** = Bronze | **W** = White

☉ = NON-STOCKED PRODUCT

For details, see Ameristar's Sales Policy in the catalog guide.

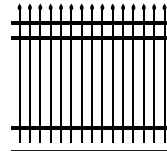

CLASSIC™

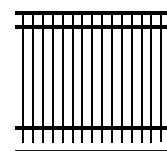

MAJESTIC™

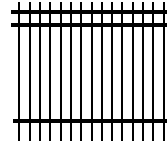

GENESIS™

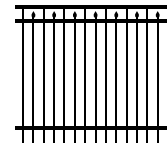

CONQUEROR™

ECHELON® | 2-RAIL & 3-RAIL POOL PANELS | 4" AIR SPACE

FLUSH BOTTOM | 6' PANEL LENGTH (71.5" actual width) | 15 PICKETS PER PANEL | 24 PANELS PER PALLET

RAIL QTY	PANEL	ITEM NUMBER	WEIGHT	STOCKING
2 POOL	4'	A0☒☉ 2486*	11 lbs	MB*
3 POOL	4.5'	A0☒☉ 3546	14 lbs	MB

☒ = FENCE STYLES AVAILABLE | **M** = Monarch* | **M** = Majestic | **R** = Conqueror

☉ = COLOR OPTIONS AVAILABLE | **B** = Black | **N** = Bronze | **W** = White

☉ = NON-STOCKED PRODUCT

For details, see Ameristar's Sales Policy in the catalog guide.

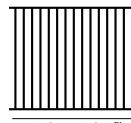

MONARCH™

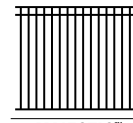

MAJESTIC™

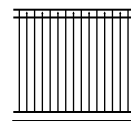

CONQUEROR™

Effective: 01/05/21

ECHELON® | 2" POSTS & ACCESSORIES

POSTS AVAILABLE IN BOX QTY ONLY | POST CAP INCLUDED WITH EACH POST

	HEIGHT	LENGTH	IN-GROUND DEPTH	ITEM NUMBER	BOX QTY	BOX WEIGHT	
DEEP FOOTER	3 RAIL	4'	6' 9"	33" / 32"*	APⓧ20081ⓧ-ⓧ4	6	23 lbs
		5'	7' 9"	33" / 32"*	APⓧ20093ⓧ-ⓧ5	6	27 lbs
		6'	8' 9"	33" / 32"*	APⓧ20105ⓧ-ⓧ6	6	30 lbs
	2 RAIL	4' POOL	6' 9"	31.25"	APⓧ20081ⓧ-P48*	6	23 lbs
	3 RAIL	4.5' POOL	7' 3"	29.5"	APⓧ20087ⓧ-M54*	6	23 lbs
SHALLOW FOOTER	3 RAIL	4'	5' 9"	21"	APⓧ20069ⓧ-ⓧ4	6	20 lbs
		5'	6' 9"	21"	APⓧ20081ⓧ-ⓧ5	6	23 lbs
		6'	7' 9"	21"	APⓧ20093ⓧ-ⓧ6	6	27 lbs
	2 RAIL	4' POOL	5' 9"	19.25"	APⓧ20069ⓧ-P48*	6	20 lbs
	3 RAIL	4.5' POOL	6' 3"	17.5"	APⓧ20075ⓧ-M54	6	23 lbs
GATE POSTS .125" WALL		4'	5' 9"	PER DWG	APⓧ20069	6	38 lbs
		4.5'	6' 3"	PER DWG	APⓧ20075	6	41 lbs
		4' / 5'	6' 9"	PER DWG	APⓧ20081	6	45 lbs
		4.5'	7' 3"	PER DWG	APⓧ20087	6	48 lbs
		5' / 6'	7' 9"	PER DWG	APⓧ20093	6	51 lbs
		6'	8' 9"	PER DWG	APⓧ20105	6	57 lbs

ⓧ = FENCE STYLES AVAILABLE | C = Classic M = Majestic / Conqueror / Monarch* G = Genesis

ⓧ = COLOR OPTIONS AVAILABLE | B = Black N = Bronze W = White

ⓧ = POST TYPE | L = Line E = End C = Corner

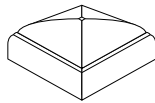

STANDARD FLAT CAP

Aluminum

CAP SIZE	ITEM NUMBER	WEIGHT
2"sq.	Aⓧ510P	.12 lbs
1.25"sq.	Aⓧ500P	.10 lbs



BALL CAP

Aluminum

CAP SIZE	ITEM NUMBER	WEIGHT
2"sq.	Hⓧ508R	.72 lbs

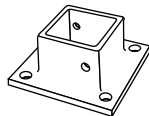

POST BASE

BASE SIZE	ITEM NUMBER	WEIGHT
2"sq.	APBⓧ20	1.2 lbs

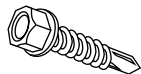

SELF DRILLING SCREWS

SIZE	ITEM NUMBER	WEIGHT
#8 x 1"	HB518P-6 / Hⓧ518P	.03 lbs
#14 x 1"	1-0007-1	.01 lbs

Effective: 01/05/21

ECHELON® | BRACKETS & PANEL ACCESSORIES

AVAILABLE IN BAG QTY ONLY



DESCRIPTION	SIZE	ITEM NUMBER	BAG QTY	BOX QTY	WEIGHT EA
Swivel Bracket	1" x 1.125"	AB⊗9	2	120	.18 lbs
<i>Bags packaged with: #10 x .625" self-drilling screws #10 x .75" self-drilling screws</i>					

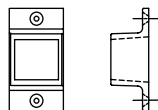

Flat Mount Bracket	1" x 1.125"	AB⊗8	2	200	.10 lbs
<i>Bags packaged with: #10 x .625" self-drilling screws</i>					

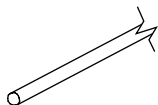

Retaining Rod	.125" x 71.375"	H532P	1	1	.25 lbs
<i>Galvanized aluminum rod / .125" diameter</i>					

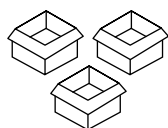

Grommet Sets	.625" sq.	X⊗16P	16	n/a	.06 lbs
---------------------	-----------	-------	----	-----	---------

⊗ = COLOR OPTIONS AVAILABLE | **B** = Black | **N** = Bronze | **W** = White

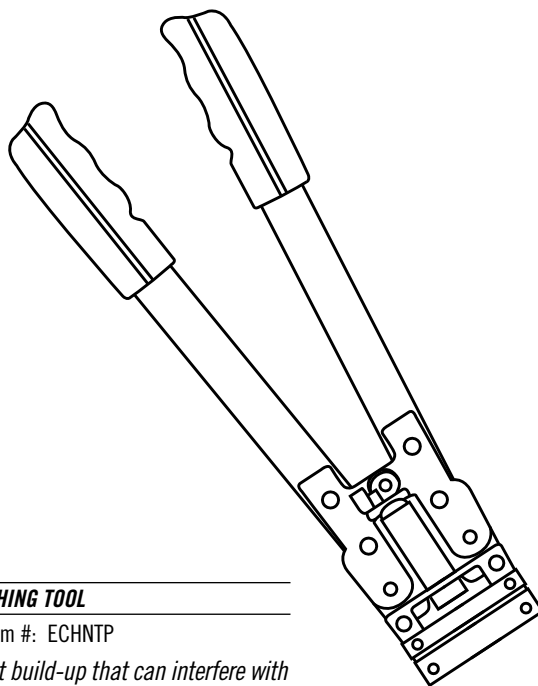

NOTCHING TOOL

3 lbs / Item #: ECHNTP

- » Ejects tabs cleanly without build-up that can interfere with efficiency during installation. Made from tempered steel & aircraft grade aluminum, this tool is built to last and makes notching Echelon rails a quick & easy process

Effective: 01/05/21

AMERISTAR

ASSA ABLOY

TO PLACE YOUR ORDER CALL 888-333-3422 | VISIT AMERISTARFENCE.COM

ECHELON® | FINIALS & ADORNMENTS

FINIALS & PICKET PLUGS FOR GENESIS PANELS ONLY | ADORNMENTS FOR 3-RAIL PANELS ONLY



QUAD FLARE

.625" / .13 lbs
 A⊗ 301R1



TRIAD

.625" / .13 lbs
 A⊗ 302R1



ROYALTY

.625" / .14 lbs
 A⊗ 303R1

.625" PRESS FIT PICKET FINIALS

» 15 finials required per panel

⊗ = **COLOR OPTIONS AVAILABLE** | **B** = Black | **N** = Bronze
W = White

*NOTE: Picket plugs are available in bag quantities only /
 16 plugs per bag: Item number
 AB502-16 = **B** / AW502-16 = **W***



SERPENTINE SCROLL

4 lbs / H⊗ 059

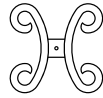

BUTTERFLY SCROLL

4 lbs / H⊗ 058NR1

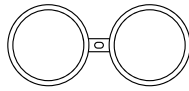

DOUBLE RING

4 lbs / A⊗ 102

ECHELON PANEL ADORNMENTS

» Fit in between / on the face of top rails on 3-rail panels

» #10 self-drilling screws included

» H⊗ 059 & H⊗ 058 = 20 per box | A⊗ 102 = 11 per box

⊗ = **COLOR OPTIONS AVAILABLE** | **B** = Black | **N** = Bronze
W = White

ECHELON® | CUSTOM FINISHES

WARRANTY ON CUT COMPONENTS VOID WITHOUT PROPER TOUCH-UP APPLICATION*

**For details & the guidelines for the proper 3-step process, see Ameristar's Sales Policy in the catalog guide*

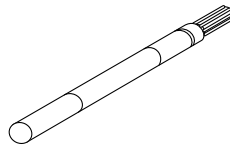

PAINT PEN

.5 lbs / P⊗ 100

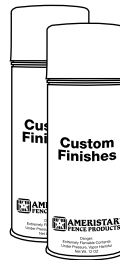

SPRAY PAINT

1.1 lbs / F⊗ 100

⊗ = **COLOR OPTIONS AVAILABLE** | **B** = Black | **N** = Bronze | **W** = White

Effective: 01/05/21

ECHELON® | CONSTRUCTION SPECIFICATION 32 31 19

ALUMINUM ORNAMENTAL FENCE SYSTEM – INTERNALLY SECURED

PART 1 - GENERAL

1.01 WORK INCLUDED

The contractor shall provide all labor, materials and all necessary items for the installation of the Echelon® Residential ornamental aluminum fence system defined herein at (*specify project site*).

1.02 RELATED WORK

Section ___ - Earthwork

Section ___ - Concrete

1.03 SYSTEM DESCRIPTION

The manufacturer shall supply a total ornamental aluminum fencing system of the Ameristar® Echelon® (*specify Classic™, Majestic™, Genesis™, Conqueror™, Monarch Pool™, Majestic Pool™, Conqueror Pool™*) design. The system shall include all components (*i.e., pickets, posts, rails, gates and hardware*) required.

1.04 QUALITY ASSURANCE

The contractor shall provide laborers and supervisors who are thoroughly familiar with the type of construction involved and the materials specified.

1.05 REFERENCES

- **ASTM B117** – Practice for Operating Salt-Spray (Fog) Apparatus
- **ASTM B221** – Standard Specification for Aluminum and Aluminum-Alloy Extruded Bars, Rods, Wire, Profiles and Tubes
- **ASTM D523** – Test Method for Specular Gloss
- **ASTM D1654** – Test Method for Evaluation of Painted or Coated Specimens Subjected to Corrosive Environments
- **ASTM D2244** – Test Method for Calculation of Color Differences from Instrumentally Measured Color Coordinates
- **ASTM D2794** – Test Method for Resistance of Organic Coatings to the Effects of Rapid Deformation (Impact)
- **ASTM D3359** – Test Method for Measuring Adhesion by Tape Test
- **ASTM D6695** – Standard Practice for Xenon-Arc Exposures of Paint and Related Coatings
- **AAMA 2603** – Voluntary Specification, Performance Requirements & Test Procedures for Pigmented organic Coatings on Aluminum Extrusions and Panels

1.06 SUBMITTAL

The manufacturer's submittal package shall be submitted prior to installation to confirm compliance with all requirements for materials specified in this section.

1.07 PRODUCT HANDLING AND STORAGE

Upon receipt at the job site, all materials shall be checked to ensure that no damages occurred during shipping or handling. Materials shall be stored in such a manner to ensure proper ventilation and drainage and to protect against damage, weather, vandalism and theft.

PART 2 - MATERIALS

2.01 MANUFACTURER

The ornamental fence system shall conform to Ameristar's Echelon aluminum ornamental fencing, (*specify Classic, Majestic, Genesis, Conqueror, Majestic Pool, Conqueror Pool*) 3-rail or (*Monarch Pool 2-rail*), style manufactured by Ameristar Fence Products, Inc. in Tulsa, Oklahoma.

2.02 MATERIAL

- Aluminum material for fence framework (*i.e., tubular pickets, rails and posts*) shall conform to the requirements of **ASTM B221**. The aluminum extrusions for posts and rails shall be Alloy and Temper Designation **6005-T5**. The aluminum extrusions for pickets shall be Alloy and Temper Designation **6063-T6**.
- Pickets shall be .590" square x .050" thick. Horizontal rails shall be 1.125" x 1" Forerunner™ channel with .055" thick top & internal web wall, and .072" thick side walls and shall be punched to allow picket to pass through the top of the rail. The Forerunner rail shall be constructed with an internal web insert providing a raceway for the pickets to be retained with a .125" retaining rod. Fence posts and gate posts shall meet the minimum size requirements of **Table 1**.
- Accessories: Aluminum castings shall be used for all post caps, scrolls, finials, and other miscellaneous hardware. Hinges and latches shall be fabricated from aluminum, stainless steel or composite materials.

2.03 FABRICATION

- Pickets, rails and posts shall be pre-cut to specified lengths. ForeRunner rails shall be pre-punched to accept pickets. Grommets shall be inserted into the pre-punched holes in the rails and pickets shall be inserted through the grommets so that pre-drilled picket holes align with the internal upper raceway of the ForeRunner rails (*Note: This can best be accomplished by using an alignment template*). Retaining rods shall be inserted into each ForeRunner rail so that they pass through the pre-drilled holes in each picket, thus completing the panel assembly. Panels to be preassemble by manufacturer.

Effective: 01/05/21

ECHELON® | CONSTRUCTION SPECIFICATION 32 31 19

ALUMINUM ORNAMENTAL FENCE SYSTEM – INTERNALLY SECURED

- B.** The manufactured framework shall be subjected to the Ameristar thermal stratification coating process (*high-temperature, in-line, multi-stage, and multi-layer*) including, as a minimum, a six-stage pretreatment/wash and an electrostatic spray application of a polyester finish. The topcoat shall be a “no-mar” TGIC polyester powder coat finish with a minimum thickness of 2 mils (0.0508mm). The color shall be (*specify Black, Bronze, or White*). The stratification-coated framework shall be capable of meeting the performance requirements for each quality characteristic shown in **Table 2**.
- C.** Swing gates shall be fabricated using Echelon Forerunner rail material, 1.25" sq. x .125" gate ends, and .625" sq. x .050 pickets. All rail and upright intersections shall be joined by welding. All picket and rail intersections shall also be joined by welding.

PART 3 - EXECUTION

3.01 PREPARATION

All new installation shall be laid out by the contractor in accordance with the construction plans.

3.02 FENCE INSTALLATION

Fence post shall be spaced according to **Table 3**. For installations that must be raked to follow sloping grades, the post spacing dimension must be measured along the grade. Fence panels rails shall be inserted into punched posts and affixed with fasteners. Posts shall be set in concrete footers per manufacturers recommendation (*Note: In some cases, local restrictions of freezing weather conditions may require a greater depth*). The “Earthwork” and “Concrete” sections of this specification shall govern material requirements for the concrete footer. Posts setting by other methods such as plated posts or grouted core-drilled footers are permissible only if shown by engineering analysis to be sufficient in strength for the intended application.

3.03 FENCE INSTALLATION MAINTENANCE

When cutting/drilling rails or posts adhere to the following steps to seal the exposed surfaces; 1) Remove all metal shavings from cut area. 2) Apply custom finish paint matching fence color. Failure to seal exposed surfaces per steps 1 & 2 above will negate warranty. Ameristar spray cans or paint pens shall be used to finish exposed surfaces; it is recommended that paint pens be used to prevent overspray. Use of non-Ameristar parts or components will negate the manufactures’ warranty.

3.04 GATE INSTALLATION

Gate posts shall be spaced according to the manufacturers’ gate drawings, dependent on standard out-to-out gate leaf dimensions and gate hardware selected. Type and quantity of gate hinges shall be based on the application; weight, height, and number of gate cycles. The manufacturers’ gate drawings shall identify the necessary gate hardware required for the application. Gate hardware shall be provided by the manufacture of the gate and shall be installed per manufacturer’s recommendations.

3.05 CLEANING

The contractor shall clean the jobsite of excess materials; post-hole excavations shall be scattered uniformly away from posts.

SEE REFERENCED TABLES ON THE FOLLOWING PAGE

Effective: 01/05/21

ECHELON® | CONSTRUCTION SPECIFICATION 32 31 19

ALUMINUM ORNAMENTAL FENCE SYSTEM – INTERNALLY SECURED

TABLE 1

MINIMUM SIZES FOR ECHELON POSTS	
FENCE POSTS	PANEL HEIGHTS
2"sq x .060"	Up to 6' height
GATE LEAF	GATE HEIGHT
	up to & including 6'
up to 6'	2"sq x .125" aluminum

TABLE 2

COATING PERFORMANCE REQUIREMENTS		
QUALITY CHARACTERISTICS	ASTM TEST METHOD	PERFORMANCE REQUIREMENTS
ADHESION	D3359 – METHOD B	Adhesion (retention of coating) over 90% of test area (tape and knife kit test).
CORROSION RESISTANCE	B117, D1654	Corrosion resistance over 1,000 hours (scribed per D1654; failure mode is accumulation of 1/8" coating loss from scribe or medium #8 blisters)
IMPACT RESISTANCE	D2794	Impact resistance over 60" lb. (forward impact using 0.625" ball).
WEATHERING RESISTANCE	D822 D2244, D523 (60° method)	Weathering resistance over 1,000 hours (failure mode is 60% loss of gloss or color variance of more than 3 delta-E color units).

TABLE 3

ECHELON POST SPACING / PUNCHED POSTS	
POST SIZE	2"
POST SETTINGS	72" o.c.

*When using swivel brackets on either or both ends of a panel installation, care must be taken to ensure the spacing between post and adjoining pickets meets applicable codes. This will require trimming one or both ends of the panel.

Effective: 01/05/21

ECHELON® | LIMITED LIFETIME WARRANTY

INTERNALLY SECURED STEEL ORNAMENTAL FENCE PRODUCTS

Echelon® Residential Ornamental Aluminum Fencing System is manufactured from the highest quality materials by skilled craftsmen to meet the highest standards of workmanship in the industry. Extruded aluminum framework shall be subject to a six stage pretreatment/wash followed by an electrostatic spray application of a “no-mar” TGIC polyester powder coat finish, which provides the protection necessary to withstand adverse environmental conditions.

The powder coated surface on all aluminum framework (*i.e., pickets, rails and posts*) by AMERISTAR® is guaranteed under normal and proper usage, against cracking, peeling, chipping, blistering or corroding. Normal and proper usage does not include physical damage or abrasion to the protective coating.

Echelon Residential Ornamental Aluminum Fencing System framework is also guaranteed for the same period of time against defects in workmanship or materials.

Should any ornamental aluminum fence framework manufactured by Ameristar Fence Products fail in accordance with any of the above conditions, Ameristar Fence Products warrants to the original purchaser their redemption through replacement or renewal. The decision as to which method of redemption is allowed is solely at the discretion of Ameristar. Notice of failure under the conditions of this warranty shall be sent to Ameristar Fence Products or its authorized representative, in writing, together with proof of purchase and shall specify the nature of the defect and when it was first observed. If contractor uses non Ameristar parts/components this will negate warranty. Should the fence be improperly installed, Ameristar Fence Products shall not be responsible for guaranteed performance or appearance of the material. Neither does this guarantee apply when failure or damage is due to improper use or application, abuse or misuse, vandalism or acts of God. Ameristar Fence Products reserves the right to inspect the material to determine validity of the claim.

Upon validation of the claim by Ameristar Fence Products or its authorized representative, redemption by replacement or renewal shall be made by Ameristar Fence Products. Reimbursement for the costs of removal and installation of materials are not included in the guarantee, nor will Ameristar Fence Products provide those services.

The above constitutes the complete warranty by the manufacturer. No other agreement, written or implied, is valid. Ameristar Fence Products does not authorize any other person or agent to make any other express warranties. Ameristar Fence Products neither assumes nor authorizes any other person or agent to assume any other liability in connection with Echelon Residential Ornamental Aluminum Fencing

System. Some jurisdictions do not allow limitations on how long an implied warranty lasts, nor do they allow an exclusion or limitation of incidental or consequential damages; therefore, the limitations and exclusions noted herein may not apply.

Effective: 01/05/21

ECHELON® | SINGLE SWING GATE SPECIFICATIONS

1.25"sq x .125" wall GATE ENDS | .590"sq x .054" wall PICKETS

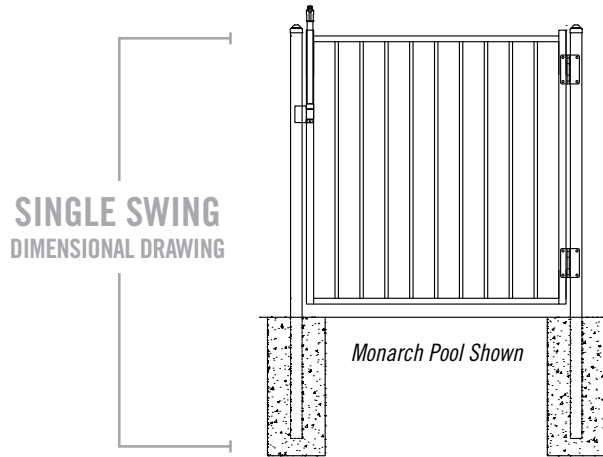

OPENING	LEAF WIDTH*	DSKM D&D GATE HARDWARE KIT			DSKP D&D POOL GATE HARDWARE KIT		
		HC	LC	P _s	HC	LC	P _s
3½'	36.5"	1.125"	.75"	38.375"	1.125"	.75"	38.375"
4'	45"	1.125"	.75"	46.875"	1.125"	.75"	46.875"
5'	62.5"	1.125"	.75"	64.375"	1.125"	.75"	64.375"
6'	71"	1.125"	.75"	72.875"	1.125"	.75"	72.875"

SINGLE SWING HARDWARE KITS & POST INTERSPACES

W = width* | HC = hinge clearance | LC = latch clearance | P_s = gate post spacing**
 * From outside to outside | ** From inside to inside

DSKM gate hardware included / see section for specific details
 DSKP gate hardware (pool gates) included / see section for specific details

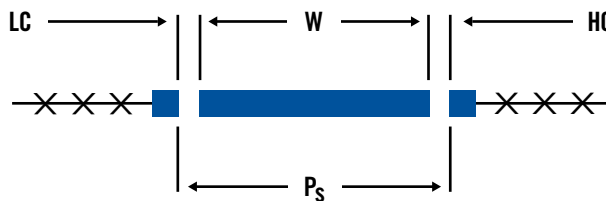

Effective: 01/05/21

ECHELON® | DOUBLE SWING GATE SPECIFICATIONS

1.25"sq x .125" wall GATE ENDS | .590"sq x .054" wall PICKETS

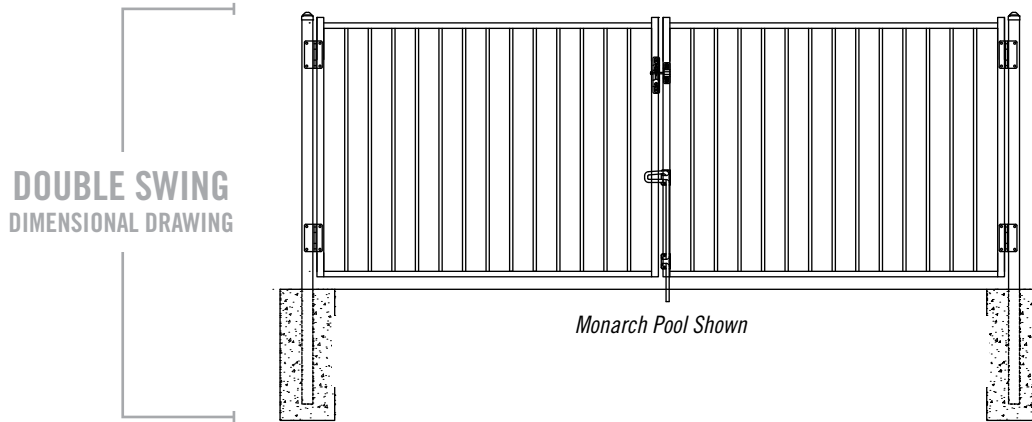

D&D GATE HARDWARE KIT

OPENING	LEAF WIDTH*	HC	LC	P _d
7'	36.5"	.75"	.75"	75.25"
8'	45"	.75"	.75"	92.25"
10'	62.5"	.75"	.75"	127.25"
12'	71"	.75"	.75"	144.25"

DOUBLE SWING HARDWARE KITS & POST INTERSPACES

W = width (x2)* | HC = hinge clearance (x2) | LC = latch clearance
 P_d = gate post spacing**
 * From outside to outside | ** From inside to inside

DDKM gate hardware included / see section for specific details

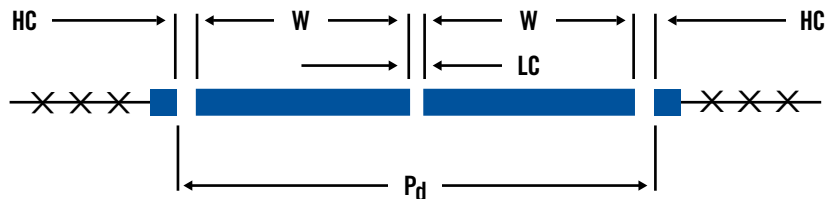

Effective: 01/05/21

ECHELON® | 3-RAIL SINGLE SWING GATES

4" AIR GAP | STANDARD BOTTOM | GATE HARDWARE INCLUDED

	OPENING	LEAF WIDTH	ITEM NUMBER	PICKET QTY	WEIGHT	STOCKING
4' HEIGHT	3½'	36½"	AO☒⊗346-42M	7	14 lbs	☉
	4'	45"	AO☒⊗346-48M	9	17 lbs	☉
	5'	62½"	AO☒⊗346-60M	13	20 lbs	☉
	6'	71"	AO☒⊗346-72M	15	22 lbs	☉
5' HEIGHT	3½'	36½"	AO☒⊗358-42M	7	17 lbs	☉
	4'	45"	AO☒⊗358-48M	9	19 lbs	☉
	5'	62½"	AO☒⊗358-60M	13	23 lbs	☉
	6'	71"	AO☒⊗358-72M	15	25 lbs	☉
6' HEIGHT	3½'	36½"	AO☒⊗370-42M	7	19 lbs	☉
	4'	45"	AO☒⊗370-48M	9	22 lbs	☉
	5'	62½"	AO☒⊗370-60M	13	26 lbs	☉
	6'	71"	AO☒⊗370-72M	15	28 lbs	☉

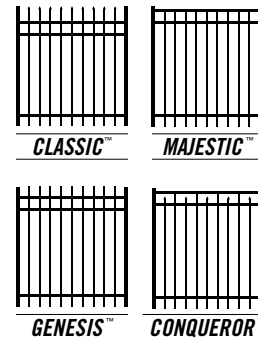

☒ = FENCE STYLES AVAILABLE | C = Classic M = Majestic G = Genesis R = Conqueror
 ⊗ = COLOR OPTIONS AVAILABLE | B = Black N = Bronze W = White

ECHELON® | 2-RAIL & 3-RAIL POOL SINGLE SWING GATES

4" AIR GAP | FLUSH BOTTOM | GATE HARDWARE INCLUDED

	OPENING	LEAF WIDTH	ITEM NUMBER	PICKET QTY	WEIGHT	STOCKING
4' HEIGHT	3½'	36½"	AOM⊗248F-42P*	7	15 lbs	☉
	4'	45"	AOM⊗248F-48P*	9	17 lbs	☉
	5'	62½"	AOM⊗248F-60P*	13	19 lbs	☉
	6'	71"	AOM⊗248F-72P*	15	21 lbs	☉
4½' HEIGHT	3½'	36½"	AO☒⊗354F-42P	7	18 lbs	☉
	4'	45"	AO☒⊗354F-48P	9	20 lbs	☉
	5'	62½"	AO☒⊗354F-60P	13	23 lbs	☉
	6'	71"	AO☒⊗354F-72P	15	25 lbs	☉

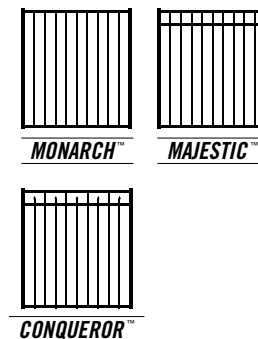

☒ = FENCE STYLES AVAILABLE | M = Monarch* M = Majestic R = Conqueror
 ⊗ = COLOR OPTIONS AVAILABLE | B = Black N = Bronze W = White

Effective: 01/05/21

ECHELON® | 3-RAIL DOUBLE SWING GATES

4" AIR GAP | STANDARD BOTTOM | GATE HARDWARE INCLUDED

	OPENING	LEAF WIDTH	ITEM NUMBER	PICKET QTY	WEIGHT	STOCKING
4' HEIGHT	7'	36½"	AO☒Ⓞ346-84MD	14	30 lbs	☉
	8'	45"	AO☒Ⓞ346-96MD	18	36 lbs	☉
	10'	62½"	AO☒Ⓞ346-120MD	26	42 lbs	☉
	12'	71"	AO☒Ⓞ346-144MD	30	46 lbs	☉
5' HEIGHT	7'	36½"	AO☒Ⓞ358-84MD	14	36 lbs	☉
	8'	45"	AO☒Ⓞ358-96MD	18	40 lbs	☉
	10'	62½"	AO☒Ⓞ358-120MD	26	48 lbs	☉
6' HEIGHT	12'	71"	AO☒Ⓞ358-144MD	30	52 lbs	☉
	7'	36½"	AO☒Ⓞ370-84MD	14	40 lbs	☉
	8'	45"	AO☒Ⓞ370-96MD	18	46 lbs	☉
	10'	62½"	AO☒Ⓞ370-120MD	26	54 lbs	☉
	12'	71"	AO☒Ⓞ370-144MD	30	58 lbs	☉

☒ = FENCE STYLES AVAILABLE | C = Classic M = Majestic G = Genesis R = Conqueror

Ⓞ = COLOR OPTIONS AVAILABLE | B = Black N = Bronze W = White

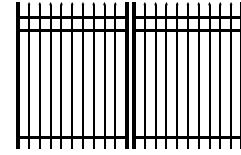

CLASSIC™

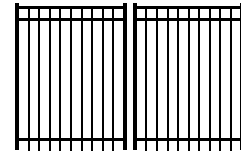

MAJESTIC™

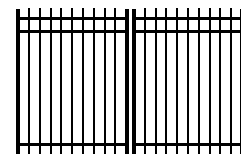

GENESIS™

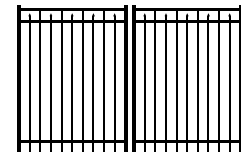

CONQUEROR™

ECHELON® | 2-RAIL & 3-RAIL POOL DOUBLE SWING GATES

4" AIR GAP | FLUSH BOTTOM | GATE HARDWARE INCLUDED

	OPENING	LEAF WIDTH	ITEM NUMBER	PICKET QTY	WEIGHT	STOCKING
4' HEIGHT	7'	36½"	AOMⓄ248F-84PD*	14	30 lbs	☉
	8'	45"	AOMⓄ248F-96PD*	16	34 lbs	☉
	10'	62½"	AOMⓄ248F-120PD*	18	38 lbs	☉
	12'	71"	AOMⓄ248F-144PD*	20	42 lbs	☉
4½' HEIGHT	7'	36½"	AO☒Ⓞ354F-84PD	14	36 lbs	☉
	8'	45"	AO☒Ⓞ354F-96PD	16	40 lbs	☉
	10'	62½"	AO☒Ⓞ354F-120PD	18	46 lbs	☉
	12'	71"	AO☒Ⓞ354F-144PD	30	50 lbs	☉

☒ = FENCE STYLES AVAILABLE | M = Monarch* M = Majestic R = Conqueror

Ⓞ = COLOR OPTIONS AVAILABLE | B = Black N = Bronze W = White

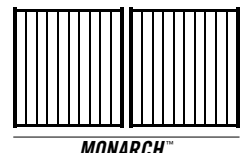

MONARCH™

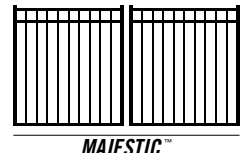

MAJESTIC™

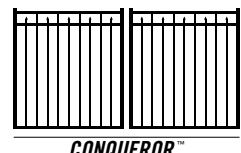

CONQUEROR™

Effective: 01/05/21

Effective: 01/05/21

ECHELON® | SINGLE SWING ARCHED GATE SPECIFICATIONS

1.25"sq x .125" wall GATE ENDS | .590"sq x .054" wall PICKETS

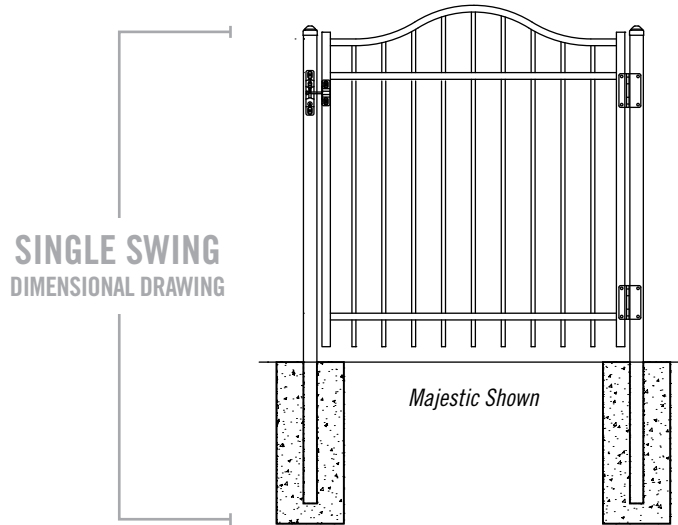

D&D GATE HARDWARE KIT D&D POOL GATE HARDWARE KIT

OPENING	LEAF WIDTH*	HC	LC	P _s	HC	LC	P _s
3½'	36.5"	1.125"	.75"	38.375"	1.125"	.75"	38.375"
4'	45"	1.125"	.75"	46.875"	1.125"	.75"	46.875"
5'	62.5"	1.125"	.75"	64.375"	1.125"	.75"	64.375"
6'	71"	1.125"	.75"	72.875"	1.125"	.75"	72.875"

W = width* | HC = hinge clearance | LC = latch clearance | P_s = gate post spacing**
 * From outside to outside | ** From inside to inside

DSKM gate hardware included / see section for specific details
DSKP gate hardware (pool gates) included / see section for specific details

SINGLE SWING
 ARCHED
 HARDWARE KITS &
 POST INTERSPACES

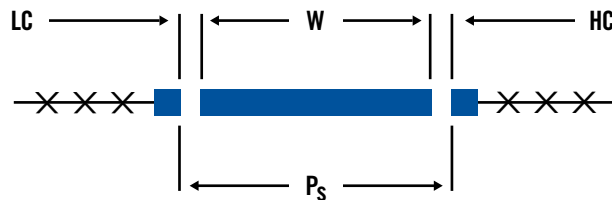

Effective: 01/05/21

ECHELON® | 3-RAIL SINGLE SWING ARCHED GATES

4" AIR GAP | STANDARD BOTTOM | GATE HARDWARE INCLUDED

	OPENING	LEAF WIDTH	ITEM NUMBER	PICKET QTY	WEIGHT	STOCKING
4' HEIGHT	3½'	36½"	A0☒Ⓞ346-42AM	7	16 lbs	☉
	4'	45"	A0☒Ⓞ346-48AM	9	19 lbs	☉
	5'	62½"	A0☒Ⓞ346-60AM	13	25 lbs	☉
5' HEIGHT	3½'	36½"	A0☒Ⓞ358-42AM	7	19 lbs	☉
	4'	45"	A0☒Ⓞ358-48AM	9	21 lbs	☉
	5'	62½"	A0☒Ⓞ358-60AM	13	28 lbs	☉
6' HEIGHT	3½'	36½"	A0☒Ⓞ370-42AM	7	21 lbs	☉
	4'	45"	A0☒Ⓞ370-48AM	9	24 lbs	☉
	5'	62½"	A0☒Ⓞ370-60AM	13	31 lbs	☉
	6'	71"	A0☒Ⓞ370-72AM	15	33 lbs	☉

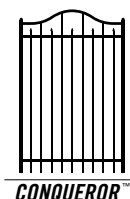
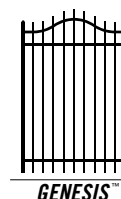
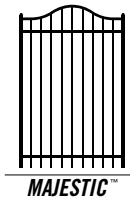

☒ = FENCE STYLES AVAILABLE | C = Classic M = Majestic G = Genesis R = Conqueror
 ☉ = COLOR OPTIONS AVAILABLE | B = Black N = Bronze W = White

ECHELON® | 2-RAIL & 3-RAIL POOL SINGLE SWING ARCHED GATES

4" AIR GAP | FLUSH BOTTOM | GATE HARDWARE INCLUDED

	OPENING	LEAF WIDTH	ITEM NUMBER	PICKET QTY	WEIGHT	STOCKING
4' HEIGHT	3½'	36½"	A0☒Ⓞ248F-42AP*	7	14 lbs	☉
	4'	45"	A0☒Ⓞ248F-48AP*	9	17 lbs	☉
	5'	62.5"	A0☒Ⓞ248F-60AP*	13	22 lbs	☉
	6'	71"	A0☒Ⓞ248F-72AP*	15	26 lbs	☉
4½' HEIGHT	3½'	36½"	A0☒Ⓞ354F-42AP	7	14 lbs	☉
	4'	45"	A0☒Ⓞ354F-48AP	9	17 lbs	☉
	5'	62.5"	A0☒Ⓞ354F-60AP	13	22 lbs	☉
	6'	71"	A0☒Ⓞ354F-72AP	15	26 lbs	☉

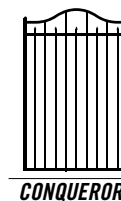
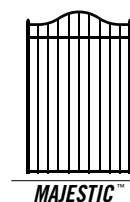
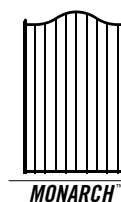

☒ = FENCE STYLES AVAILABLE | M = Monarch* M = Majestic R = Conqueror
 ☉ = COLOR OPTIONS AVAILABLE | B = Black N = Bronze W = White

Effective: 01/05/21